



PRICE LIST

Effective Date: November 21, 2016

Tri-One

Multi-Use Table Collection

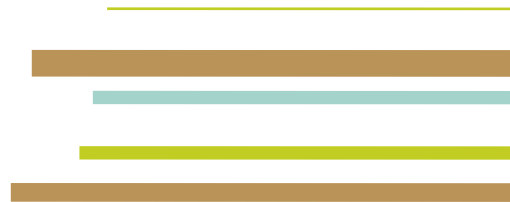

Clearly Green

level®, BIFMA's sustainability certification program for furniture, is a comprehensive and transparent third-party certification program. The level mark attests that the product, the manufacturing facility, and the company responsible for the product brand, have been evaluated against the multi-attribute criteria of the ANSI/BIFMA e3 Furniture Sustainability Standard. Products certified under the level® program can be chosen with confidence. All Indiana Furniture case-goods and seating solutions are BIFMA level® 2 Certified.



A number of Indiana Furniture products have achieved Intertek's ETL Environmental VOC Certification and are recognized as products that safeguard indoor air quality. The certification — which extends to Elevate, Gesso, Revolutions, Madera, Resilience, Canvas, Tri-One, all Conference, Reception and Seating solutions, demonstrates that Indiana Furniture's products conform to the ANSI/BIFMA Furniture Emissions Standards (M7.1/X7.1-2011) for Office Furniture Systems and Components. They also earn points for LEED Credit 4.5.



Once cured by UV lighting, our UVAdvantage® finish does not emit irritable toxins, formaldehyde, or solvents into the air creating safe work environments within new furniture installations. This has allowed us to earn Indoor Air Quality Certification on our products with UVAdvantage finish. Our UVAdvantage finish process greatly reduces hazardous air pollutants which contribute to smog formation. Excess UV finish is recaptured over and over again reducing waste material within our facilities.



Forest Stewardship Council® (FSC®) Chain-of-Custody(CoC) Certification is an assurance that wood based materials used in products come from forests that meet stringent environmental, social, and economic standards. It is the path taken by raw materials from the forest to the consumer, including all successive stages of harvesting, processing, manufacturing and distribution. Only products from FSC CoC companies can claim the FSC designation, assurance of a socially and environmentally responsible purchasing decision. FSC CoC Certification is recognized by the U.S. Green Building Council's (USGBC) LEED Rating System for environmentally focused design. From a customer perspective, the FSC label represents a promise made; CoC standards are the mechanism FSC uses to ensure that promise is delivered. Indiana Furniture has been awarded FSC CoC Certification, by GFA Certification GmbH, an independent third-party accredited by the FSC to certify companies to their international standards. The certification (certificate number GFA-COC-002183; license code FSC-C110951) is available on most Indiana Furniture products.



Warranty 5
 General Information and Conditions of Sale 6

VENEER

Modular Conference Tables

Square Edge..... 10-17
 Knife Edge 28-35

Meeting Tables

Square Edge..... 18-24
 Knife Edge 36-42

LAMINATE

Training Tables

Square Edge..... 61-63
 Knife Edge 83-85
 Urethane Edge..... 90-91

Modular Conference Tables

Square Edge..... 46-53
 Knife Edge 68-75

Meeting Tables

Square Edge..... 54-60
 Knife Edge 76-82

Power and Accessories 92-97

Subject to the limitations set forth in this warranty, Indiana Furniture Industries, Inc. (“**Indiana Furniture**”) warrants to the original purchaser all product in this price list (“**Product**”) to be free from defects in material and workmanship given normal use for a twelve year period from the date of manufacture. During the applicable warranty period, Indiana Furniture, as its sole obligation, will repair or replace (in Indiana Furniture’s sole discretion) any Product, part, or component covered by this warranty and sold after November 21, 2016, which fails under normal use as a result of a defect in material or workmanship. Normal use is defined as the equivalent of a single shift, 40-hour work week. Indiana Furniture will repair or replace the defective Product, part, or component with a comparable Product, part or component.

Warranty periods are limited for certain Products and parts as follows:

12-year Warranty (from the date of manufacture)

- Seating Mechanisms
- Veneers
- Laminates
- Casters and Glides

5-year Warranty (from the date of manufacture)

- Triple Play Series
- Electrical Components
- Pneumatic Cylinders
- Textiles, Foam, and Decorative Trim
- Swivel Arm Pads
- Keyboard kits
- Lighting

2-year Warranty (from the date of manufacture)

- All Sit-To-Stand Mechanisms

THIS WARRANTY DOES NOT COVER:

- Damage caused by a carrier or third party
- Normal or routine wear and tear
- Appearance, durability, quality, behavior, colorfastness or any other attribute of customer’s own materials or any non-standard Indiana Furniture material (including Maharam, Momentum, Mayer, UltraFabrics) specified by the customer and applied to a Product
- Color, grain or texture of wood, laminate and other covering materials
- Changes in wood or fabric color due to aging or exposure to light

As the manufacturer of the Product, Indiana Furniture stands behind its craftsmanship and pledges to do everything it can to reasonably resolve, as quickly as possible, any problems you may have with the Product within the terms and conditions of this warranty.

If you encounter a defect covered by the foregoing warranty, you should contact the dealer from whom you purchased the Product. If the dealer is unable to resolve your warranty issues, you should contact Indiana Furniture. Please ensure that you have all of the pertinent facts when contacting the dealer or Indiana Furniture, including the model number and factory order number from the inspection label attached to the Product.

INDIANA FURNITURE IS NOT PROVIDING, AND SPECIFICALLY DISCLAIMS, ANY OTHER WARRANTIES FOR THE PRODUCTS, EXPRESS OR IMPLIED, INCLUDING ANY IMPLIED WARRANTY OF MERCHANTABILITY OR FITNESS FOR A PARTICULAR PURPOSE. INDIANA FURNITURE SHALL NOT BE LIABLE TO PURCHASER OR ANY THIRD PARTY FOR CONSEQUENTIAL, INCIDENTAL, INDIRECT OR SPECIAL DAMAGES, INCLUDING, WITHOUT LIMITATION, DAMAGES ARISING OUT OF OR RESULTING IN ANY MALFUNCTIONS, DELAYS, LOSS OF PROFIT, INTERRUPTION OF BUSINESS, PERSONAL INJURY, BODILY INJURY, DEATH, DISMEMBERMENT, OR PROPERTY DAMAGE.

Indiana Furniture Industries, Inc.
Attn: Customer Service
1224 Mill Street, P.O. Box 270
Jasper, Indiana 47547-0270
800.422.5727
Fax 812.482.9035
custserv@indianafurniture.com

ORDERING INFORMATION

All orders should be emailed to neworders@indianafurniture.com. Orders can be faxed to 812-482-9035. Orders can also be mailed to:

Indiana Furniture
P.O. Box 270
1224 Mill Street
Jasper, IN 47547-0270

ORDER PROCEDURE

All orders must include purchase order number, billing address, ship-to address and phone number, and any special instructions.

When ordering casegoods, give complete quantity, model number, finish and any other options. When ordering seating, give complete quantity, model number, finish, fabric and any other options.

Within each series, an example of "How to Order" is illustrated at the bottom of each page. For further clarification of order procedure, contact Customer Service.

PRICING

All prices shown are suggested retail prices F.O.B. Point of Origin, freight prepaid and allowed to one continental US destination. Prices, specifications and materials are subject to change without notice. Possession and/or distribution of this price list does not in itself constitute an offer to sell. Orders can be received only from authorized Indiana Furniture dealers. Orders will be billed at prices prevailing at time of shipment, unless acknowledged prior to the effective date of the price change, in which case billing will be at the price acknowledged.

ACKNOWLEDGEMENT

All orders will be acknowledged promptly, showing how the order was entered, its approximate shipping date and other pertinent information. This acknowledgement is the final agreement between the customer and Indiana Furniture and is the exclusive statement of the terms thereof. Please examine this acknowledgement carefully and advise Indiana Furniture immediately of any discrepancies.

BUYER'S OBLIGATION: RIGHTS OF SELLER

If Indiana Furniture shall at any time doubt Buyer's financial responsibility, Indiana Furniture may decline to make shipments hereunder except upon receipt of cash payment in advance or security or other proof of responsibility satisfactory to Indiana Furniture. If buyer fails in any way to fulfill the terms and conditions set forth herein, Indiana Furniture may defer shipments until such default is corrected. Remedies provided herein shall be in addition to, and not in lieu of other remedies. Buyer agrees to abide by payment terms as listed on invoice. Buyer shall pay all reasonable costs and expenses, including attorney and collection fees, and late fees, incurred by Seller in connection with any amounts due for goods ordered.

CANCELLATIONS AND CHANGES

Due to immediate production on build to order items, all orders are considered firm and are not subject to cancellation or change without approval from Indiana Furniture. All approved changes are subject to additional charges and revised lead times.

PRODUCT DESIGN AND SPECIFICATION CHANGES

Indiana Furniture reserves the right to make changes in design and construction or discontinue products without prior notice.

REPAIR CHARGES

Indiana Furniture will only pay repair charges if Customer Service gives prior written authorization. No repair charge will be paid without advance approval at which time you will be issued a repair authorization number that will allow you to invoice Indiana Furniture for the completed work.

WAREHOUSE STORAGE CHARGES

If a shipment is held beyond 14 calendar days at your request a **.067% per calendar day** (2% per month) storage charge will be assessed. The effective date will be 14 calendar days after the acknowledged ship date. Further, the prices applied to the order will be those in effect at the time of shipment.

DAMAGED MERCHANDISE

The consignee is responsible for filing claims with the carrier for damage and shortages. Claims for both obvious and concealed damage must be filed within 15 calendar days, and the damaged merchandise must not have been moved from the original receiving location. All damaged merchandise, including the cartons and packing materials, must be retained for inspection by either the carrier or by an Indiana Furniture Sales Representative. Indiana Furniture reserves the right to select the most cost effective way to repair or replace the damaged item. Once you have notified the carrier, please contact Customer Service for further assistance.

Obvious Damage/Missing Cartons - Do not refuse merchandise damaged in transit. Indiana Furniture recommends the consignee inspect all merchandise upon arrival. If a shipment is received damaged or short, note all information on carrier's copy and your copy of freight bill and delivery receipt. Notify the delivering carrier and file a claim immediately. Pending the results of your claim, either Indiana Furniture or the carrier will cover 100% of the cost to repair or replace the damaged or missing item.

Concealed Damage - If concealed damage is discovered, notify the delivering carrier at once and request an inspection. This must be done within **15 calendar days of delivery**. If the carrier will not perform the inspection, you should prepare an affidavit that you contacted them, noting the time and date, and that they failed to comply with your request. This, along with the other papers in your possession, will support the claim. Pending the results of your claim, the cost to repair or replace the item will be covered 1/3 by the carrier and 2/3 by Indiana Furniture for shipments less than a full truckload and 100% by Indiana Furniture for shipments of full truckloads.

RETURN MERCHANDISE

Merchandise will not be accepted for return without an RGA (Return Goods Authorization) issued by Indiana Furniture. We will consider issuing RGA's for the following reasons:

1. Manufacturing defect (inspected by Indiana Furniture representative)
2. Indiana Furniture order processing error
3. Shipping error
4. Mis-marked cartons
5. Duplicated shipments

If you have any questions as to whether your reason for return qualifies for consideration, please contact your Customer Service Representative. Merchandise must be returned within 60 days of the RGA issued date, or within 60 days upon receipt of replacement product to receive credit. Returns due to mis-marked cartons must also be returned in the original cartoning, with shipping labels intact, to receive credit.

All merchandise being returned must be properly packed and protected to ensure no further damage is incurred during transportation back to an Indiana Furniture facility. Upon receipt, all returned merchandise will be thoroughly inspected and the results compared to the reason for return stated on the RGA. Any discrepancies, such as additional damage, signs of usage, missing parts, etc., will result in an adjustment to the amount of credit issued.

DELIVERY AND FREIGHT CHARGES

All shipments are F.O.B. Point of Origin, Jasper, IN, freight prepaid and allowed dock to dock on 53' trailer. Ownership and responsibility of the merchandise becomes that of the buyer upon delivery to the freight company. Shipments into Alaska, Hawaii, Canada, Mexico, Puerto Rico and other exports are freight prepaid and allowed to port of exit.

Indiana Furniture reserves the right to select the most appropriate carrier and routing on all shipments. Indiana Furniture will attempt to accommodate requests for favored carriers and delivery times. Deliveries requested Monday through Thursday, after 3pm, will be assessed a \$250 per truck after hours fee. Deliveries requested after 3pm on Friday or on weekends, will be assessed a \$500 per truck weekend delivery fee.

Inside delivery and installation services are not included in the pricing shown. Any deviation from dock-to-dock delivery, such as but not limited to, non-dock, residential, or inside delivery must be specified on the order. Should these services be requested or required, all charges incurred will be charged to the "Sold To" of the order.

Orders of less than 750 pounds will be assessed a handling charge of \$75.00 Net Per Order. (This will be waived for items shipped via a small package carrier.)

BIFMA AND ANSI TESTING

Indiana Furniture is a member of the Business and Institutional Furniture Manufacturer's Association (BIFMA). Tests developed by the BIFMA and approved by the American National Standards Institute (ANSI) determine the strength and durability of casegoods and seating in its everyday use. Although this testing does not serve as a warranty or guarantee, Indiana Furniture products within this price list have been tested by an independent verifying body and meet or exceed applicable BIFMA and ANSI standards.

Tri-One™ Veneer

Multi-Use Table Collection

Square Edge



How to Order

	QTY	MODEL NO.	DESCRIPTION
TOP	6	85-2472MCT	Finish Color JW
MODESTY	6	86-0872MD	Laminate Color PL
GANGING	5	08-1505GB	
BASE	6	08-0227APL4	
DATA	6	01-DUOBEZELW	

Specifications

TOPS

Tops are 1-3/16" thick select grade sliced hardwood veneers in Cherry, Maple, American Black Walnut, and composite veneers. Tops are available in Square Edge (H) profile with 1.5mm edge banding. Tops are pre-drilled for the specified base assembly and for ganging applications.

LEG ASSEMBLY

All leg styles are powder-coated aluminum and include a 5mm steel mounting plate. Envy style legs are aluminum extrusion while Vantage style legs are steel welded. Envy Y-Legs include troughs which act as modesty panels and route cables cleanly to the legs where a removable panel provides access. All legs include adjustable glides or casters.

GANGING

All modular conference tables are pre-drilled with threaded inserts for ganging applications. Ganging brackets include quick release thumb screws for ease of use. No tools required.

POWER PORTS

Power ports are available for under-surface mount or routed into work surfaces. Units comply with FCC Part 15A and UL. Both standard plugs and daisy-chain connections are offered. Daisy chain applications are non-sequential and connect up to 8 modules.



Finish Options

WOOD VENEER (W)



Clear Maple
CM



Light Maple
LM



Golden Cherry
GC



Bourbon Cherry
BC



Autumn Cherry
AC



Dark Cherry
DC



Artisan Walnut
AW



Legacy Walnut
LW



Harvest Walnut
HW



Mahogany on Walnut
MW



Presidential Walnut
PW



Columbian Walnut
CO



Espresso Walnut
EW

COMPOSITE VENEER (CV)



Toasted Coconut
TC



Champagne Royale
CR



Sunglow Walnut
SW



Cherry Spice
CS



Java Wenge
JW



Chanel Driftwood
CD

Edge Options



Square
H

WIRE MANAGEMENT GROMMET

Optional black grommets are available in Modular Conference Tops. Please specify any combination of Left, Right, and Center and add \$47 list for each grommet.

Specify & Add: GL – Grommet Left
GR – Grommet Right
GC – Grommet Center

Grommets may be ordered in non-standard locations. Please call Customer Service to assist with how to order and additional lead time requirements.

24" Modular Conference Tables

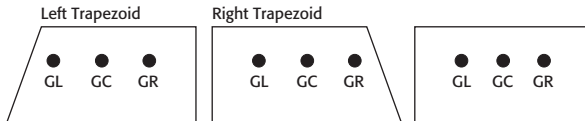

GL/GR – 10" from end based on widest dimension, 13 3/8" from user side
GC – Grommet Center – 13 3/8" from user side

30" Modular Conference Tables

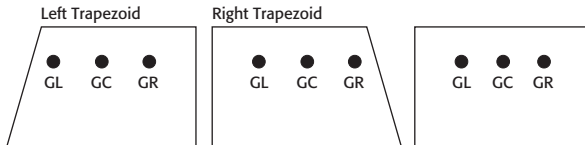

GL/GR – 10" from end based on widest dimension, 19 3/8" from user side
GC – Grommet Center – 19 3/8" from user side

POWER ACCESSORIES

Indiana Furniture offers Power Accessories for modular conference tops, and rectangular, ellipse or view meeting tables that can be mounted below the worksurface or in the worksurface top. Power Accessories that include a bezel frame will be routed for field placement at no additional charge. See pages 92-97 to specify and order Power Accessories.

Power Accessories will be routed on center, left to right:

- 24" Modular Conference Tables – 13 3/8" from user side
- 30" Modular Conference Tables – 19 3/8" from user side
- Meeting Tables – On center, front to back

Tri-One™ Series – Veneer
 Multi-Use Tables – Square Edge

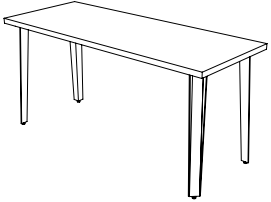
Item	Model No.	W	D	H	Ship Wt	Cubic Ft	List Price
RECTANGULAR MODULAR CONFERENCE TOP SQUARE EDGE 	85-3084MCT	84	30	—	76.4	6	W\$ 1282 CV\$ 1346
	85-3072MCT	72	30	—	65.5	5.1	W\$ 1039 CV\$ 1091
	85-3060MCT	60	30	—	54.6	4.3	W\$ 932 CV\$ 979
	85-3048MCT	48	30	—	43.7	3.5	W\$ 699 CV\$ 734
	85-2484MCT	84	24	—	61.1	4.9	W\$ 1191 CV\$ 1251
	85-2472MCT	72	24	—	52.4	4.2	W\$ 959 CV\$ 1007
	85-2460MCT	60	24	—	43.7	3.5	W\$ 870 CV\$ 914
	85-2448MCT	48	24	—	34.9	2.8	W\$ 645 CV\$ 677

Description

- Flexible Sizes Available, See Page 11
- Legs Required – Assembly Required
- Pre-Drilled for Ganging Brackets
- Tops 60" and Larger Include Stiffener Bar

What You Need – Leg Assembly *(Not Available to be Sold Separately)*
Envy Post Leg

	Weight	Cubes	List Price
08-0227APL4	20	1.6	\$ 513
Set of 4			

Vantage Post Leg

	Weight	Cubes	List Price
08-0227SPL4	20	1.6	\$ 415
Set of 4			



Envy Post Leg

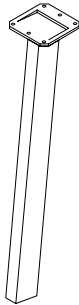

Vantage Post Leg

Description

- Adjustable Glides

Options: Specify & Add
Ganging

08-1505GB	Ganging Bracket Kit – Set of 2 with Thumb Screws	\$ 48
-----------	--	-------

Modesty Panel
Fixed

	For	List Price
85-0884MD	84	W\$ 644 CV\$ 676
85-0872MD	72	W\$ 626 CV\$ 657
85-0860MD	60	W\$ 589 CV\$ 618
85-0848MD	48	W\$ 571 CV\$ 600

- Also Available in Laminate, See Laminate Price List

Power & Data

See Pages 92 – 97 for Power and Data Options

Tri-One™ Series – Veneer
 Multi-Use Tables – Square Edge

Item	Model No.	W	D	H	Ship Wt	Cubic Ft	List Price
RECTANGULAR MODULAR CONFERENCE TOP SQUARE EDGE - FLEXIBLE SIZES	85-FLEXMCT30	84 - 73	30	—	76.4	6	W\$ 1282 CV\$ 1346
		72 - 61	30	—	65.5	5.1	W\$ 1039 CV\$ 1091
		60 - 49	30	—	54.6	4.3	W\$ 932 CV\$ 979
	85-FLEXMCT24	84 - 73	24	—	61.1	4.9	W\$ 1191 CV\$ 1251
		72 - 61	24	—	52.4	4.2	W\$ 959 CV\$ 1007
		60 - 49	24	—	43.7	3.5	W\$ 870 CV\$ 914
	85-FLEXMCT18	84 - 73	18	—	47.8	3.8	W\$ 870 CV\$ 914
		60 - 49	18	—	34.9	2.8	W\$ 645 CV\$ 677

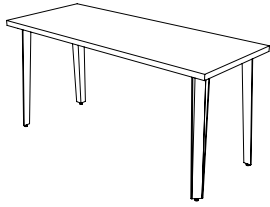

Envy Post Leg

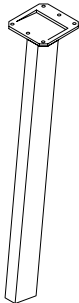

Vantage Post Leg

Description

- Must Specify Width In One Inch Increments from 36" to 84"
- Legs Required – Assembly Required
- Tops 60" and Larger Include Stiffener Bar
- Pre-Drilled for Ganging Brackets

What You Need – Leg Assembly *(Not Available to be Sold Separately)*
Envy Post Leg

	Weight	Cubes	List Price
08-0227APL4	20	1.6	\$ 513
Set of 4			

Vantage Post Leg

	Weight	Cubes	List Price
08-0227SPL4	20	1.6	\$ 415
Set of 4			

Description

- Adjustable Glides

Options: Specify & Add
Ganging

08-1505GB	Ganging Bracket Kit – Set of 2 with Thumb Screws	\$ 48
-----------	--	-------

Modesty Panel
Fixed



	For	List Price
85-FLEXMD	84 - 73	W\$ 644 CV\$ 676
	72 - 61	W\$ 626 CV\$ 657
	60 - 49	W\$ 589 CV\$ 618
	48 - 36	W\$ 571 CV\$ 600

- Also Available in Laminate, See Laminate Price List

Power & Data

See Pages 92 – 97 for Power and Data Options

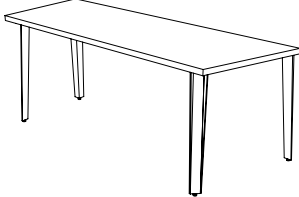
Tri-One™ Series – Veneer
Multi-Use Tables – Square Edge

Item	Model No.	W	D	H	Ship Wt	Cubic Ft	List Price
 LEFT TRAPEZOID MODULAR CONFERENCE TOP SQUARE EDGE  User Side	85-3084LMCT	84	30	—	76.4	6	W\$ 1231 CV\$ 1293
	85-3072LMCT	72	30	—	65.5	5.1	W\$ 995 CV\$ 1045
	85-3060LMCT	60	30	—	54.6	4.3	W\$ 897 CV\$ 942
	85-3048LMCT	48	30	—	43.7	3.5	W\$ 670 CV\$ 704
	85-2484LMCT	84	24	—	61.1	4.9	W\$ 1146 CV\$ 1203
	85-2472LMCT	72	24	—	52.4	4.2	W\$ 919 CV\$ 965
	85-2460LMCT	60	24	—	43.7	3.5	W\$ 836 CV\$ 878
	85-2448LMCT	48	24	—	34.9	2.8	W\$ 616 CV\$ 647

Description

- Flexible Sizes Available, See Page 13
- Legs Required – Assembly Required
- Pre-Drilled for Ganging Brackets
- Tops 60" and Larger Include Stiffener Bar

What You Need – Leg Assembly *(Not Available to be Sold Separately)*
Envy Post Leg

	Weight	Cubes	List Price
08-0227APL4	20	1.6	\$ 513
Set of 4			

Vantage Post Leg

	Weight	Cubes	List Price
08-0227SPL4	20	1.6	\$ 415
Set of 4			

Description

- Adjustable Glides

Options: Specify & Add
Ganging

08-1505GB	Ganging Bracket Kit – Set of 2 with Thumb Screws	\$ 48
-----------	--	-------

Modesty Panel
Fixed – Use with 30" Trapezoids

	For	List Price
85-0884MDT30	84	W\$ 679 CV\$ 713
85-0872MDT30	72	W\$ 614 CV\$ 645
85-0860MDT30	60	W\$ 577 CV\$ 606
85-0848MDT30	48	W\$ 543 CV\$ 570

Fixed – Use with 24" Trapezoids

	For	List Price
85-0884MDT24	84	W\$ 666 CV\$ 699
85-0872MDT24	72	W\$ 599 CV\$ 629
85-0860MDT24	60	W\$ 565 CV\$ 593
85-0848MDT24	48	W\$ 530 CV\$ 557

- Also Available in Laminate, See Laminate Price List

Power & Data

See Pages 92 – 97 for Power and Data Options

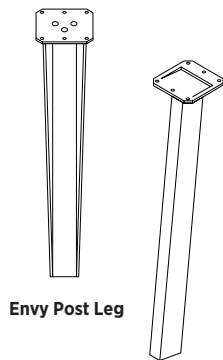

Envy Post Leg

Vantage Post Leg

Tri-One™ Series – Veneer
 Multi-Use Tables – Square Edge

Item	Model No.	W	D	H	Ship Wt	Cubic Ft	List Price
LEFT TRAPEZOID MODULAR CONFERENCE TOP SQUARE EDGE	85-FLEXLMCT30	84 - 73	30	—	76.4	6	W\$ 1231 CV\$ 1293
		72 - 61	30	—	65.5	5.1	W\$ 995 CV\$ 1045
		60 - 49	30	—	54.6	4.3	W\$ 897 CV\$ 942
		48 - 36	30	—	43.7	3.5	W\$ 670 CV\$ 704
 User Side	85-FLEXLMCT24	84 - 73	24	—	61.1	4.9	W\$ 1146 CV\$ 1203
		72 - 61	24	—	52.4	4.2	W\$ 919 CV\$ 965
		60 - 49	24	—	43.7	3.5	W\$ 836 CV\$ 878
		48 - 36	24	—	34.9	2.8	W\$ 616 CV\$ 647

Description

- Must Specify Width In One Inch Increments from 36" to 84"
- Legs Required – Assembly Required
- Tops 60" and Larger Include Stiffener Bar
- Pre-Drilled for Ganging Brackets

What You Need – Leg Assembly *(Not Available to be Sold Separately)*
Envy Post Leg

	Weight	Cubes	List Price
08-0227APL4	20	1.6	\$ 513
Set of 4			

Vantage Post Leg

	Weight	Cubes	List Price
08-0227SPL4	20	1.6	\$ 415
Set of 4			

Description

- Adjustable Glides

Options: Specify & Add
Ganging

08-1505GB	Ganging Bracket Kit – Set of 2 with Thumb Screws	\$ 48
-----------	--	-------

Modesty Panel
Fixed – Use with 30" Trapezoids

	For	List Price
85-FLEXMDTRP30	84 - 73	W\$ 679 CV\$ 713
	72 - 61	W\$ 614 CV\$ 645
	60 - 49	W\$ 577 CV\$ 606
	48 - 36	W\$ 543 CV\$ 570

Fixed – Use with 24" Trapezoids

	For	List Price
85-FLEXMDTRP24	84 - 73	W\$ 666 CV\$ 699
	72 - 61	W\$ 599 CV\$ 629
	60 - 49	W\$ 565 CV\$ 593
	48 - 36	W\$ 530 CV\$ 557

- Also Available in Laminate, See Laminate Price List

Power & Data

See Pages 92 – 97 for Power and Data Options

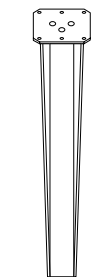

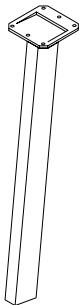

Envy Post Leg

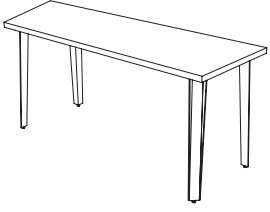

Vantage Post Leg

Tri-One™ Series – Veneer
 Multi-Use Tables – Square Edge

Item	Model No.	W	D	H	Ship Wt	Cubic Ft	List Price
RIGHT TRAPEZOID MODULAR CONFERENCE TOP SQUARE EDGE   User Side	85-3084RMCT	84	30	—	76.4	6	W\$ 1231 CV\$ 1293
	85-3072RMCT	72	30	—	65.5	5.1	W\$ 995 CV\$ 1045
	85-3060RMCT	60	30	—	54.6	4.3	W\$ 897 CV\$ 942
	85-3048RMCT	48	30	—	43.7	3.5	W\$ 670 CV\$ 704
	85-2484RMCT	84	24	—	61.1	4.9	W\$ 1146 CV\$ 1203
	85-2472RMCT	72	24	—	52.4	4.2	W\$ 919 CV\$ 965
	85-2460RMCT	60	24	—	43.7	3.5	W\$ 836 CV\$ 878
	85-2448RMCT	48	24	—	34.9	2.8	W\$ 616 CV\$ 647

Description

- Flexible Sizes Available, See Page 15
- Legs Required – Assembly Required
- Pre-Drilled for Ganging Brackets
- Tops 60" and Larger Include Stiffener Bar

What You Need – Leg Assembly *(Not Available to be Sold Separately)*
Envy Post Leg

	Weight	Cubes	List Price
08-0227APL4	20	1.6	\$ 513
Set of 4			

Vantage Post Leg

	Weight	Cubes	List Price
08-0227SPL4	20	1.6	\$ 415
Set of 4			

Description

- Adjustable Glides

Options: Specify & Add
Ganging

08-1505GB	Ganging Bracket Kit – Set of 2 with Thumb Screws	\$ 48
-----------	--	-------

Modesty Panel
Fixed – Use with 30" Trapezoids

	For	List Price
85-0884MDT30	84	W\$ 679 CV\$ 713
85-0872MDT30	72	W\$ 614 CV\$ 645
85-0860MDT30	60	W\$ 577 CV\$ 606
85-0848MDT30	48	W\$ 543 CV\$ 570

Fixed – Use with 24" Trapezoids

	For	List Price
85-0884MDT24	84	W\$ 666 CV\$ 699
85-0872MDT24	72	W\$ 599 CV\$ 629
85-0860MDT24	60	W\$ 565 CV\$ 593
85-0848MDT24	48	W\$ 530 CV\$ 557

- Also Available in Laminate, See Laminate Price List

Power & Data

See Pages 92 – 97 for Power and Data Options

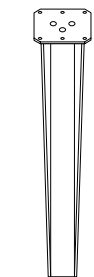

Envy Post Leg

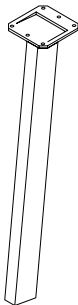

Vantage Post Leg

Tri-One™ Series – Veneer
 Multi-Use Tables – Square Edge

Item	Model No.	W	D	H	Ship Wt	Cubic Ft	List Price
RIGHT TRAPEZOID MODULAR CONFERENCE TOP SQUARE EDGE	85-FLEXRMCT30	84 - 73	30	—	76.4	6	W\$ 1231 CV\$ 1293
		72 - 61	30	—	65.5	5.1	W\$ 995 CV\$ 1045
		60 - 49	30	—	54.6	4.3	W\$ 897 CV\$ 942
		48 - 36	30	—	43.7	3.5	W\$ 670 CV\$ 704
 User Side	85-FLEXRMCT24	84 - 73	24	—	61.1	4.9	W\$ 1146 CV\$ 1203
		72 - 61	24	—	52.4	4.2	W\$ 919 CV\$ 965
		60 - 49	24	—	43.7	3.5	W\$ 836 CV\$ 878
		48 - 36	24	—	34.9	2.8	W\$ 616 CV\$ 647

Description

- Must Specify Width In One Inch Increments from 36" to 84"
- Legs Required – Assembly Required
- Tops 60" and Larger Include Stiffener Bar
- Pre-Drilled for Ganging Brackets

What You Need – Leg Assembly *(Not Available to be Sold Separately)*
Envy Post Leg

	Weight	Cubes	List Price
08-0227APL4	20	1.6	\$ 513
Set of 4			

Vantage Post Leg

	Weight	Cubes	List Price
08-0227SPL4	20	1.6	\$ 415
Set of 4			

Description

- Adjustable Glides

Options: Specify & Add
Ganging

08-1505GB	Ganging Bracket Kit – Set of 2 with Thumb Screws	\$ 48
-----------	--	-------

Modesty Panel
Fixed – Use with 30" Trapezoids

	For	List Price
85-FLEXMDTRP30	84 - 73	W\$ 679 CV\$ 713
	72 - 61	W\$ 614 CV\$ 645
	60 - 49	W\$ 577 CV\$ 606
	48 - 36	W\$ 543 CV\$ 570

Fixed – Use with 24" Trapezoids

	For	List Price
85-FLEXMDTRP24	84 - 73	W\$ 666 CV\$ 699
	72 - 61	W\$ 599 CV\$ 629
	60 - 49	W\$ 565 CV\$ 593
	48 - 36	W\$ 530 CV\$ 557

- Also Available in Laminate, See Laminate Price List

Power & Data

See Pages 92 – 97 for Power and Data Options

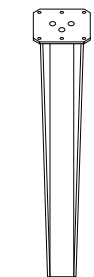

Envy Post Leg

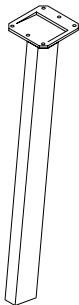

Vantage Post Leg

Tri-One™ Series – Veneer
 Multi-Use Tables – Square Edge

Item	Model No.	W	D	H	Ship Wt	Cubic Ft	List Price
PENTAGON MODULAR CONFERENCE TOP SQUARE EDGE	85-30MCTP	58 - 48 ⁵ / ₈	18 - 25	—	44	3.6	W\$ 781 CV\$ 820

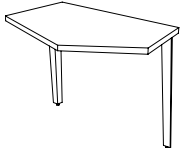

For Use with 30" Modular Tops

85-24MCTP	46 ¹ / ₃ - 37	18 - 23 ¹ / ₂	—	33.7	2.8	W\$ 690 CV\$ 725
-----------	-------------------------------------	-------------------------------------	---	------	-----	---------------------

For Use with 24" Modular Tops

Description

- Not a Freestanding Table
- Pre-Drilled for Ganging Brackets
- Legs Required – Assembly Required
- Ganging Brackets Required

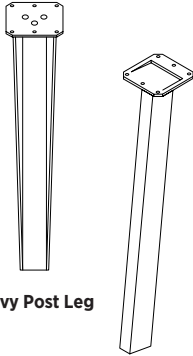

Envy Post Leg

Vantage Post Leg

What You Need – Leg Assembly *(Not Available to be Sold Separately)*
Envy Post Leg

	Weight	Cubes	List Price
08-0227APL2	10	0.8	\$ 294
Set of 2			

Vantage Post Leg

	Weight	Cubes	List Price
08-0227SPL2	10	0.8	\$ 245
Set of 2			

Description

- Adjustable Glides

Options: Specify & Add
Ganging – Requires 2 Sets

08-1505GB	Ganging Bracket Kit – Set of 2 with Thumb Screws	\$ 48
-----------	--	-------

Tri-One™ Series – Veneer
 Multi-Use Tables – Square Edge

Item	Model No.	W	D	H	Ship Wt	Cubic Ft	List Price
BRIDGE MODULAR CONFERENCE TOP SQUARE EDGE	85-3090MCTB	42 $\frac{3}{8}$	30	—	18.2	2	W\$ 872 CV\$ 916

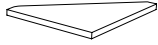

For Use with 30" Modular Tops
 85-2490MCTB

34	24	—	11.6	1.3	W\$ 616 CV\$ 647
----	----	---	------	-----	---------------------

For Use with 24" Modular Tops

Description

- 90° Bridge Conference Top with Square Edge
- Connects Two Conference Tops
- Pre-Drilled for Ganging Brackets
- Not a Freestanding Unit
- Ganging Brackets Required

Options: Specify & Add

Ganging – Requires 2 Sets

08-1505GB	Ganging Bracket Kit – Set of 2 with Thumb Screws	\$ 48
-----------	--	-------

BRIDGE MODULAR CONFERENCE TOP SQUARE EDGE	85-3045MCTB	27 $\frac{1}{8}$	30	—	16.1	2	W\$ 633 CV\$ 665
--	-------------	------------------	----	---	------	---	---------------------



For Use with 30" Modular Tops
 85-2445MCTB

22 $\frac{3}{8}$	24	—	10.8	1.4	W\$ 565 CV\$ 593
------------------	----	---	------	-----	---------------------

For Use with 24" Modular Tops

Description

- 45° Bridge Conference Top with Square Edge
- Connects Two Conference Tops
- Pre-Drilled for Ganging Brackets
- Not a Freestanding Unit
- Ganging Brackets Required

Options: Specify & Add

Ganging – Requires 2 Sets

08-1505GB	Ganging Bracket Kit – Set of 2 with Thumb Screws	\$ 48
-----------	--	-------

BRIDGE MODULAR CONFERENCE TOP SQUARE EDGE	85-3030MCTB	19 $\frac{3}{4}$	30	—	11.4	1.5	W\$ 593 CV\$ 623
--	-------------	------------------	----	---	------	-----	---------------------



For Use with 30" Modular Tops
 85-2430MCTB

16 $\frac{3}{8}$	24	—	8.6	1.1	W\$ 537 CV\$ 564
------------------	----	---	-----	-----	---------------------

For Use with 24" Modular Tops

Description

- 30° Bridge Conference Top with Square Edge
- Connects Two Conference Tops
- Pre-Drilled for Ganging Brackets
- Not a Freestanding Unit
- Ganging Brackets Required

Options: Specify & Add

Ganging – Requires 2 Sets

08-1505GB	Ganging Bracket Kit – Set of 2 with Thumb Screws	\$ 48
-----------	--	-------

Tri-One™ Series – Veneer
 Multi-Use Tables – Square Edge

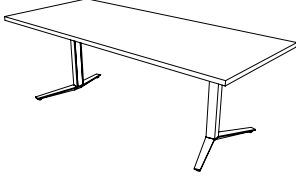
Item	Model No.	W	D	H	Ship Wt	Cubic Ft	List Price
RECTANGULAR MEETING TABLES SQUARE EDGE 	85-4296MT	96	42	—	122.2	9.4	W\$ 1476 CV\$ 1550
	55" Kneespace 85-4284MT	84	42	—	106.9	8.2	W\$ 1385 CV\$ 1454
	47" Kneespace 85-4272MT	72	42	—	91.7	7.1	W\$ 1231 CV\$ 1293
	39" Kneespace 85-4260MT	60	42	—	76.4	5.7	W\$ 1129 CV\$ 1185
	31½" Kneespace 85-3696MT	96	36	—	104.8	8.1	W\$ 1332 CV\$ 1399
	55" Kneespace 85-3684MT	84	36	—	92	7.1	W\$ 1239 CV\$ 1301
	47" Kneespace 85-3672MT	72	36	—	78.6	6.1	W\$ 1128 CV\$ 1184
	39" Kneespace 85-3660MT	60	36	—	65.5	5.1	W\$ 1037 CV\$ 1089
	31½" Kneespace						

Description

- Seated Height Bases Required – Assembly Required

What You Need – Base *(Not Available to be Sold Separately)*
X-Base (2 Bases Required)

	Weight	Cubes	List Price
08-2630LXB	27	14.5	\$ 724

Y-Base

	KS	Weight	Cubes	List Price
08-2828YLG96 For 96" Tables	55	47	6.5	\$ 1030
08-2828YLG84 For 84" Tables	47	43	5.4	\$ 1016
08-2828YLG72 For 72" Tables	39	39	4.3	\$ 994
08-2828YLG60 For 60" Tables	31½	35	3.2	\$ 955

Power & Data

See Pages 92 – 97 for Power and Data Options

Large X-Base Detail

Y-Base Detail

Tri-One™ Series – Veneer
 Multi-Use Tables – Square Edge

Item	Model No.	W	D	H	Ship Wt	Cubic Ft	List Price
SOFT RECTANGULAR MEETING TABLES SQUARE EDGE	85-4296SMT	96	42	—	122.2	9.4	W\$ 1425 CV\$ 1496
	55" Kneespace						
	85-4284SMT	84	42	—	106.9	8.2	W\$ 1341 CV\$ 1408
	47" Kneespace						
	85-4272SMT	72	42	—	91.7	7.1	W\$ 1191 CV\$ 1251
	39" Kneespace						
	85-4260SMT	60	42	—	76.4	5.7	W\$ 1095 CV\$ 1150
	31½" Kneespace						
	85-3696SMT	96	36	—	104.8	8.1	W\$ 1283 CV\$ 1347
	55" Kneespace						
85-3684SMT	84	36	—	92	7.1	W\$ 1197 CV\$ 1257	
47" Kneespace							
85-3672SMT	72	36	—	78.6	6.1	W\$ 1091 CV\$ 1146	
39" Kneespace							
85-3660SMT	60	36	—	65.5	5.1	W\$ 1005 CV\$ 1055	
31½" Kneespace							

Description

- Seated Height Bases Required – Assembly Required

What You Need – Base *(Not Available to be Sold Separately)*
X-Base (2 Bases Required)

	Weight	Cubes	List Price
08-2630LXB	27	14.5	\$ 724

Y-Base

	KS	Weight	Cubes	List Price
08-2828YLG96 For 96" Tables	55	47	6.5	\$ 1030
08-2828YLG84 For 84" Tables	47	43	5.4	\$ 1016
08-2828YLG72 For 72" Tables	39	39	4.3	\$ 994
08-2828YLG60 For 60" Tables	31½	35	3.2	\$ 955

Power & Data

See Pages 92 – 97 for Power and Data Options

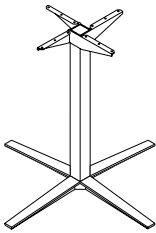
Large X-Base Detail

Y-Base Detail

Tri-One™ Series – Veneer
 Multi-Use Tables – Square Edge

Item	Model No.	W	D	H	Ship Wt	Cubic Ft	List Price
SQUARE MEETING TABLES SQUARE EDGE	85-4242SQ	42	42	—	70	3.3	W\$ 866 CV\$ 909
	85-3636SQ	36	36	—	37	2.5	W\$ 740 CV\$ 777
	85-3030SQ	30	30	—	30	2.2	W\$ 650 CV\$ 683

Description

- Bases Required – Assembly Required

What You Need – Base *(Not Available to be Sold Separately)*
Large X-Base – For Use with 42"

	Weight	Cubes	List Price
08-2642LXB 42" High Tables	35%	20	\$ 785
08-2636LXB 36" High Tables	35%	17.2	\$ 756
08-2630LXB 30" High Tables	27	14.5	\$ 724

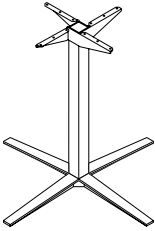
Large X-Base Detail
Small X-Base – For Use with 36" and 30"

	Weight	Cubes	List Price
08-2042SXB 42" High Tables	29%	15.9	\$ 732
08-2036SXB 36" High Tables	24	13.7	\$ 704
08-2030SXB 30" High Tables	21	11.6	\$ 675

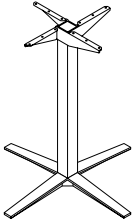
Small X-Base Detail

Tri-One™ Series – Veneer
 Multi-Use Tables – Square Edge

Item	Model No.	W	D	H	Ship Wt	Cubic Ft	List Price
SOFT SQUARE MEETING TABLES SQUARE EDGE	85-4242SSQ	42	42	—	70	3.3	W\$ 838 CV\$ 880
	85-3636SSQ	36	36	—	37	2.5	W\$ 718 CV\$ 754
	85-3030SSQ	30	30	—	30	2.2	W\$ 636 CV\$ 668

Description

- Bases Required – Assembly Required

What You Need – Base *(Not Available to be Sold Separately)*
Large X-Base – For Use with 42"

	Weight	Cubes	List Price
08-2642LXB 42" High Tables	35%	20	\$ 785
08-2636LXB 36" High Tables	35%	17.2	\$ 756
08-2630LXB 30" High Tables	35%	14.5	\$ 724

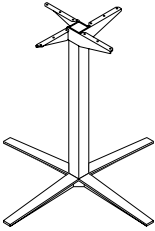
Large X-Base Detail
Small X-Base – For Use with 36" and 30"

	Weight	Cubes	List Price
08-2042SXB 42" High Tables	29%	15.9	\$ 732
08-2036SXB 36" High Tables	29%	13.7	\$ 704
08-2030SXB 30" High Tables	29%	11.6	\$ 675

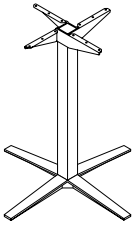
Small X-Base Detail

Tri-One™ Series – Veneer
 Multi-Use Tables – Square Edge

Item	Model No.	W	D	H	Ship Wt	Cubic Ft	List Price
ROUND MEETING TABLES SQUARE EDGE	85-4848CT	48	48	—	95	4.3	W\$ 937 CV\$ 984
	85-4242CT	42	42	—	70	3.3	W\$ 814 CV\$ 855
	85-3636CT	36	36	—	37	2.5	W\$ 712 CV\$ 748
	85-3030CT	30	30	—	30	2.2	W\$ 629 CV\$ 660

Description

- Bases Required – Assembly Required

What You Need – Base *(Not Available to be Sold Separately)*
Large X-Base – For Use with 48" and 42"

	Weight	Cubes	List Price
08-2642LXB 42" High Tables	35%	20	\$ 785
08-2636LXB 36" High Tables	35%	17.2	\$ 756
08-2630LXB 30" High Tables	35%	14.5	\$ 724

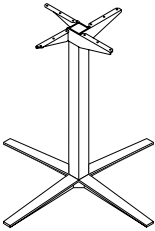
Large X-Base Detail
Small X-Base – For Use with 36" and 30"

	Weight	Cubes	List Price
08-2042SXB 42" High Tables	29%	15.9	\$ 732
08-2036SXB 36" High Tables	29%	13.7	\$ 704
08-2030SXB 30" High Tables	29%	11.6	\$ 675

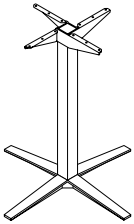
Small X-Base Detail

Tri-One™ Series – Veneer
 Multi-Use Tables – Square Edge

Item	Model No.	W	D	H	Ship Wt	Cubic Ft	List Price
SOFT VIEW MEETING TABLES SQUARE EDGE	85-4296SVT	96	42 - 36	—	122.2	9.4	W\$ 1418 CV\$ 1489
	85-4284SVT	84	42 - 36	—	106.9	8.2	W\$ 1282 CV\$ 1346
	85-4272SVT	72	42 - 36	—	91.7	7.1	W\$ 1190 CV\$ 1250

Description

- Seated Height Bases Required – Assembly Required

What You Need – Base *(Not Available to be Sold Separately)*
X-Base (2 Bases Required)

	Weight	Cubes	List Price
08-2630LXB	27	14.5	\$ 724

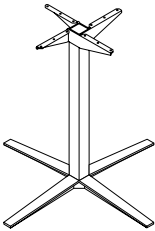
X-Base Detail
Y-Base

	Weight	Cubes	List Price
08-2828YLG96 For 96" Tables	47	6.5	\$ 1030
08-2828YLG84 For 84" Tables	43	5.4	\$ 1016
08-2828YLG72 For 72" Tables	39	4.3	\$ 994
08-2828YLG60 For 60" Tables	35	3.2	\$ 955

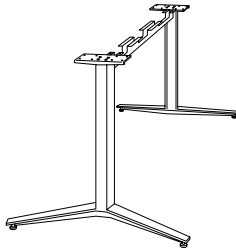
Y-Base Detail
Power & Data

See Pages 92 – 97 for Power and Data Options

Tri-One™ Series – Veneer
 Multi-Use Tables – Square Edge

Item	Model No.	W	D	H	Ship Wt	Cubic Ft	List Price
ELLIPSE MEETING TABLES SQUARE EDGE	85-4284EMT	84	48	—	106.9	8.2	W\$ 1329 CV\$ 1395

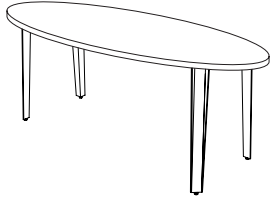

	85-3672EMT	72	30	—	78.6	6.1	W\$ 1080 CV\$ 1134
--	------------	----	----	---	------	-----	-----------------------

Description

- Includes Stiffener Bar
- Base Required – Assembly Required

What You Need – Leg Assembly *(Not Available to be Sold Separately)*
Envy Post Leg

	Weight	Cubes	List Price
08-0227APL4	20	1.6	\$ 513
Set of 4			

Vantage Post Leg

	Weight	Cubes	List Price
08-0227SPL4	20	1.6	\$ 415
Set of 4			

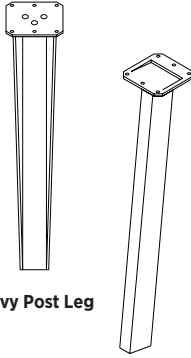

Envy Post Leg

Vantage Post Leg

Description

- Choose from Envy Post Leg or Vantage Post Leg
- Adjustable Glides
- Assembly Required

Power & Data

See Pages 92 – 97 for Power and Data Options

Tri-One™ Veneer

Multi-Use Table Collection

Knife Edge



How to Order

	QTY	MODEL NO.	DESCRIPTION
TOP	6	85-2472MCTK	Finish Color JW
MODESTY	6	86-0872MD	Laminate Color PL
GANGING	5	08-1505GB	
BASE	6	08-0227APL4	
DATA	6	01-DUOBEZELW	

Specifications



TOPS

Tops are 1-3/16" thick select grade sliced hardwood veneers in Cherry, Maple, American Black Walnut, and composite veneers. Tops are available in Knife Edge (K) profile with 1.5mm edge banding. Tops are pre-drilled for the specified base assembly and for ganging applications.

LEG ASSEMBLY

All leg styles are powder-coated aluminum and include a 5mm steel mounting plate. Envy style legs are aluminum extrusion while Vantage style legs are steel welded. Envy Y-Legs include troughs which act as modesty panels and route cables cleanly to the legs where a removable panel provides access. All legs include adjustable glides or casters.

GANGING

All modular conference tables are pre-drilled with threaded inserts for ganging applications. Ganging brackets include quick release thumb screws for ease of use. No tools required.

POWER PORTS

Power ports are available for under-surface mount or routed into work surfaces. Units comply with FCC Part 15A and UL. Both standard plugs and daisy-chain connections are offered. Daisy chain applications are non-sequential and connect up to 8 modules.

Finish Options

WOOD VENEER (W)



Clear Maple
CM



Light Maple
LM



Golden Cherry
GC



Bourbon Cherry
BC



Autumn Cherry
AC

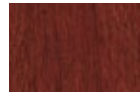

Dark Cherry
DC



Artisan Walnut
AW



Legacy Walnut
LW



Harvest Walnut
HW



Mahogany on Walnut
MW



Presidential Walnut
PW



Columbian Walnut
CO



Espresso Walnut
EW

COMPOSITE VENEER (CV)



Toasted Coconut
TC



Champagne Royale
CR



Sunglow Walnut
SW



Cherry Spice
CS



Java Wenge
JW



Chanel Driftwood
CD

Edge Options



Knife
K

WIRE MANAGEMENT GROMMET

Optional black grommets are available in Modular Conference Tops. Please specify any combination of Left, Right, and Center and add \$47 list for each grommet.

Specify & Add: GL – Grommet Left
GR – Grommet Right
GC – Grommet Center

Grommets may be ordered in non-standard locations. Please call Customer Service to assist with how to order and additional lead time requirements.

24" Modular Conference Tables

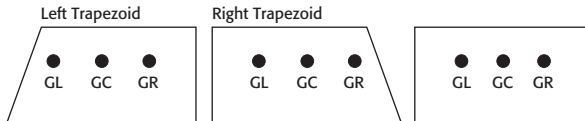

GL/GR – 10" from end based on widest dimension, 13 3/8" from user side
GC – Grommet Center – 13 3/8" from user side

30" Modular Conference Tables

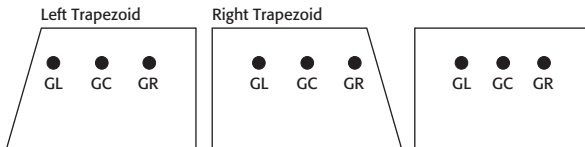

GL/GR – 10" from end based on widest dimension, 19 3/8" from user side
GC – Grommet Center – 19 3/8" from user side

POWER ACCESSORIES

Indiana Furniture offers Power Accessories for modular conference tops, and rectangular, ellipse or view meeting tables that can be mounted below the worksurface or in the worksurface top. Power Accessories that include a bezel frame will be routed for field placement at no additional charge. See pages 92-97 to specify and order Power Accessories.

Power Accessories will be routed on center, left to right:

- 24" Modular Conference Tables – 13 3/8" from user side
- 30" Modular Conference Tables – 19 3/8" from user side
- Meeting Tables – On center, front to back

Tri-One™ Series – Veneer
 Multi-Use Tables – Knife Edge

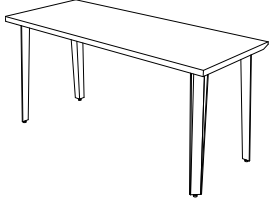
Item	Model No.	W	D	H	Ship Wt	Cubic Ft	List Price
RECTANGULAR MODULAR CONFERENCE TOP KNIFE EDGE 	85-3084MCTK	84	30	—	76.4	6	W\$ 1564 CV\$ 1642
	85-3072MCTK	72	30	—	65.5	5.1	W\$ 1268 CV\$ 1331
	85-3060MCTK	60	30	—	54.6	4.3	W\$ 1137 CV\$ 1194
	85-3048MCTK	48	30	—	43.7	3.5	W\$ 853 CV\$ 896
	85-2484MCTK	84	24	—	61.1	4.9	W\$ 1453 CV\$ 1526
	85-2472MCTK	72	24	—	52.4	4.2	W\$ 1170 CV\$ 1229
	85-2460MCTK	60	24	—	43.7	3.5	W\$ 1061 CV\$ 1114
	85-2448MCTK	48	24	—	34.9	2.8	W\$ 787 CV\$ 826

Description

- Flexible Sizes Available, See Page 29
- Legs Required – Assembly Required
- Pre-Drilled for Ganging Brackets
- Tops 60" and Larger Include Stiffener Bar

What You Need – Leg Assembly *(Not Available to be Sold Separately)*
Envy Post Leg

	Weight	Cubes	List Price
08-0227APL4	20	1.6	\$ 513
Set of 4			

Vantage Post Leg

	Weight	Cubes	List Price
08-0227SPL4	20	1.6	\$ 415
Set of 4			



Envy Post Leg

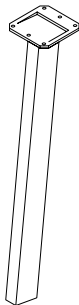

Vantage Post Leg

Description

- Adjustable Glides

Options: Specify & Add
Ganging

08-1505GB	Ganging Bracket Kit – Set of 2 with Thumb Screws	\$ 48
-----------	--	-------

Modesty Panel
Fixed

	For	List Price
85-0884MD	84	W\$ 644
		CV\$ 676
85-0872MD	72	W\$ 626
		CV\$ 657
85-0860MD	60	W\$ 589
		CV\$ 618
85-0848MD	48	W\$ 571
		CV\$ 600

- Also Available in Laminate, See Laminate Price List

Power & Data

See Pages 92 – 97 for Power and Data Options

Tri-One™ Series – Veneer
 Multi-Use Tables – Knife Edge

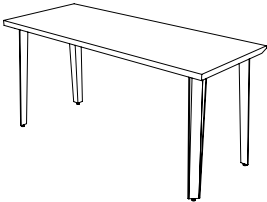
Item	Model No.	W	D	H	Ship Wt	Cubic Ft	List Price
RECTANGULAR MODULAR CONFERENCE TOP KNIFE EDGE - FLEXIBLE SIZES 	85-FLEXMCTK30	84 - 73	30	—	76.4	6	W\$ 1564 CV\$ 1642
		72 - 61	30	—	65.5	5.1	W\$ 1268 CV\$ 1331
		60 - 49	30	—	54.6	4.3	W\$ 1137 CV\$ 1194
		48 - 36	30	—	43.7	3.5	W\$ 853 CV\$ 896
	85-FLEXMCTK24	84 - 73	24	—	61.1	4.9	W\$ 1453 CV\$ 1526
		72 - 61	24	—	52.9	4.2	W\$ 1170 CV\$ 1229
		60 - 49	24	—	43.7	3.5	W\$ 1061 CV\$ 1114
		48 - 36	24	—	34.9	2.8	W\$ 787 CV\$ 826

Description

- Must Specify Width In One Inch Increments from 36" to 84"
- Legs Required – Assembly Required
- Tops 60" and Larger Include Stiffener Bar
- Pre-Drilled for Ganging Brackets

What You Need – Leg Assembly *(Not Available to be Sold Separately)*
Envy Post Leg

	Weight	Cubes	List Price
08-0227APL4	20	1.6	\$ 513
Set of 4			

Vantage Post Leg

	Weight	Cubes	List Price
08-0227SPL4	20	1.6	\$ 415
Set of 4			



Envy Post Leg

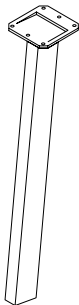

Vantage Post Leg

Description

- Adjustable Glides

Options: Specify & Add
Ganging

08-1505GB	Ganging Bracket Kit – Set of 2 with Thumb Screws	\$ 48
-----------	--	-------

Modesty Panel
Fixed



	For	List Price
85-FLEXMD	84 - 73	W\$ 644 CV\$ 676
	72 - 61	W\$ 626 CV\$ 657
	60 - 49	W\$ 589 CV\$ 618
	48 - 36	W\$ 571 CV\$ 600

- Also Available in Laminate, See Laminate Price List

Power & Data

See Pages 92 – 97 for Power and Data Options

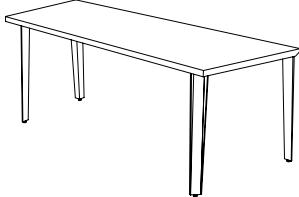
Tri-One™ Series – Veneer
 Multi-Use Tables – Knife Edge

Item	Model No.	W	D	H	Ship Wt	Cubic Ft	List Price	
  User Side	LEFT TRAPEZOID MODULAR CONFERENCE TOP KNIFE EDGE	85-3084LMCTK	84	30	—	76.4	6	W\$ 1502 CV\$ 1577
	85-3072LMCTK	72	30	—	65.5	5.1	W\$ 1214 CV\$ 1275	
	85-3060LMCTK	60	30	—	54.6	4.3	W\$ 1094 CV\$ 1149	
	85-3048LMCTK	48	30	—	43.7	3.5	W\$ 817 CV\$ 858	
	85-2484LMCTK	84	24	—	61.1	4.9	W\$ 1398 CV\$ 1468	
	85-2472LMCTK	72	24	—	52.4	4.2	W\$ 1121 CV\$ 1177	
	85-2460LMCTK	60	24	—	43.7	3.5	W\$ 1020 CV\$ 1071	
	85-2448LMCTK	48	24	—	34.9	2.8	W\$ 752 CV\$ 790	

Description

- Flexible Sizes Available, See Page 31
- Legs Required – Assembly Required
- Pre-Drilled for Ganging Brackets
- Tops 60" and Larger Include Stiffener Bar

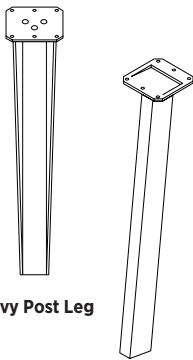
What You Need – Leg Assembly *(Not Available to be Sold Separately)*

Envy Post Leg

Vantage Post Leg

Envy Post Leg

	Weight	Cubes	List Price
08-0227APL4	20	1.6	\$ 513
Set of 4			

Description

- Adjustable Glides

Options: Specify & Add
Ganging

08-1505GB	Ganging Bracket Kit – Set of 2 with Thumb Screws	\$ 48
-----------	--	-------

Vantage Post Leg

	Weight	Cubes	List Price
08-0227SPL4	20	1.6	\$ 415
Set of 4			

Modesty Panel
Fixed – Use with 30" Trapezoids

	For	List Price
85-0884MDT30	84	W\$ 679 CV\$ 713
85-0872MDT30	72	W\$ 614 CV\$ 645
85-0860MDT30	60	W\$ 577 CV\$ 606
85-0848MDT30	48	W\$ 543 CV\$ 570

Fixed – Use with 24" Trapezoids

	For	List Price
85-0884MDT24	84	W\$ 666 CV\$ 699
85-0872MDT24	72	W\$ 599 CV\$ 629
85-0860MDT24	60	W\$ 565 CV\$ 593
85-0848MDT24	48	W\$ 530 CV\$ 557

- Also Available in Laminate, See Laminate Price List

Power & Data

See Pages 92 – 97 for Power and Data Options

Tri-One™ Series – Veneer
 Multi-Use Tables – Knife Edge

Item	Model No.	W	D	H	Ship Wt	Cubic Ft	List Price
LEFT TRAPEZOID MODULAR CONFERENCE TOP KNIFE EDGE	85-FLEXLMCTK30	84 - 73	30	—	76.4	6	W\$ 1502 CV\$ 1577
		72 - 61	30	—	65.5	5.1	W\$ 1214 CV\$ 1275
		60 - 49	30	—	54.6	4.3	W\$ 1094 CV\$ 1149
		48 - 36	30	—	43.7	3.5	W\$ 817 CV\$ 858
 User Side	85-FLEXLMCTK24	84 - 73	24	—	61.1	4.9	W\$ 1398 CV\$ 1468
		72 - 61	24	—	52.4	4.2	W\$ 1121 CV\$ 1177
		60 - 49	24	—	43.7	3.5	W\$ 1020 CV\$ 1071
		48 - 36	24	—	34.9	2.8	W\$ 752 CV\$ 790

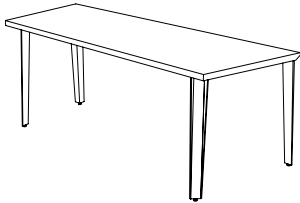

User Side

Description

- Must Specify Width In One Inch Increments from 36" to 84"
- Legs Required – Assembly Required
- Tops 60" and Larger Include Stiffener Bar
- Pre-Drilled for Ganging Brackets

What You Need – Leg Assembly *(Not Available to be Sold Separately)*
Envy Post Leg

	Weight	Cubes	List Price
08-0227APL4	20	1.6	\$ 513
Set of 4			

Vantage Post Leg

	Weight	Cubes	List Price
08-0227SPL4	20	1.6	\$ 415
Set of 4			



Envy Post Leg

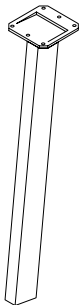

Vantage Post Leg

Description

- Adjustable Glides

Options: Specify & Add
Ganging

08-1505GB	Ganging Bracket Kit – Set of 2 with Thumb Screws	\$ 48
-----------	--	-------

Modesty Panel
Fixed – Use with 30" Trapezoids

	For	List Price
85-FLEXMDTRP30	84 - 73	W\$ 679 CV\$ 713
	72 - 61	W\$ 614 CV\$ 645
	60 - 49	W\$ 577 CV\$ 606
	48 - 36	W\$ 543 CV\$ 570

Fixed – Use with 24" Trapezoids



	For	List Price
85-FLEXMDTRP24	84 - 73	W\$ 666 CV\$ 699
	72 - 61	W\$ 599 CV\$ 629
	60 - 49	W\$ 565 CV\$ 593
	48 - 36	W\$ 530 CV\$ 557

- Also Available in Laminate, See Laminate Price List

Power & Data

See Pages 92 – 97 for Power and Data Options

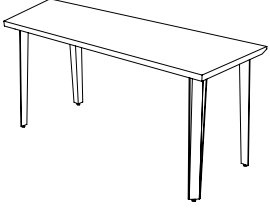
Tri-One™ Series – Veneer
 Multi-Use Tables – Knife Edge

Item	Model No.	W	D	H	Ship Wt	Cubic Ft	List Price
RIGHT TRAPEZOID MODULAR CONFERENCE TOP KNIFE EDGE   User Side	85-3084RMCTK	84	30	—	76.4	6	W\$ 1502 CV\$ 1577
	85-3072RMCTK	72	30	—	65.5	5.1	W\$ 1214 CV\$ 1275
	85-3060RMCTK	60	30	—	54.6	4.3	W\$ 1094 CV\$ 1149
	85-3048RMCTK	48	30	—	43.7	3.5	W\$ 817 CV\$ 858
	85-2484RMCTK	84	24	—	61.1	4.9	W\$ 1398 CV\$ 1468
	85-2472RMCTK	72	24	—	52.4	4.2	W\$ 1121 CV\$ 1177
	85-2460RMCTK	60	24	—	43.7	3.5	W\$ 1020 CV\$ 1071
	85-2448RMCTK	48	24	—	34.9	2.8	W\$ 752 CV\$ 790

Description

- Flexible Sizes Available, See Page 33
- Legs Required – Assembly Required
- Pre-Drilled for Ganging Brackets
- Tops 60" and Larger Include Stiffener Bar

What You Need – Leg Assembly *(Not Available to be Sold Separately)*
Envy Post Leg

	Weight	Cubes	List Price
08-0227APL4	20	1.6	\$ 513
Set of 4			

Vantage Post Leg

	Weight	Cubes	List Price
08-0227SPL4	20	1.6	\$ 415
Set of 4			

Description

- Adjustable Glides

Options: Specify & Add
Ganging

08-1505GB	Ganging Bracket Kit – Set of 2 with Thumb Screws	\$ 48
-----------	--	-------

Modesty Panel
Fixed – Use with 30" Trapezoids

	For	List Price
85-0884MDT30	84	W\$ 679 CV\$ 713
85-0872MDT30	72	W\$ 614 CV\$ 645
85-0860MDT30	60	W\$ 577 CV\$ 606
85-0848MDT30	48	W\$ 543 CV\$ 570

Fixed – Use with 24" Trapezoids

	For	List Price
85-0884MDT24	84	W\$ 666 CV\$ 699
85-0872MDT24	72	W\$ 599 CV\$ 629
85-0860MDT24	60	W\$ 565 CV\$ 593
85-0848MDT24	48	W\$ 530 CV\$ 557

- Also Available in Laminate, See Laminate Price List

Power & Data

See Pages 92 – 97 for Power and Data Options

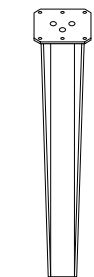

Envy Post Leg

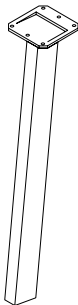

Vantage Post Leg

Tri-One™ Series – Veneer
 Multi-Use Tables – Knife Edge

Item	Model No.	W	D	H	Ship Wt	Cubic Ft	List Price
RIGHT TRAPEZOID MODULAR CONFERENCE TOP KNIFE EDGE	85-FLEXRMCTK30	84 - 73	30	—	76.4	6	W\$ 1502 CV\$ 1577
		72 - 61	30	—	65.5	5.1	W\$ 1214 CV\$ 1275
		60 - 49	30	—	54.6	4.3	W\$ 1094 CV\$ 1149
		48 - 36	30	—	43.7	3.5	W\$ 817 CV\$ 858
 User Side	85-FLEXRMCTK24	84 - 73	24	—	61.1	4.9	W\$ 1398 CV\$ 1468
		72 - 61	24	—	52.4	4.2	W\$ 1121 CV\$ 1177
		60 - 49	24	—	43.7	3.5	W\$ 1020 CV\$ 1071
		48 - 36	24	—	34.9	2.8	W\$ 752 CV\$ 790

Description

- Must Specify Width In One Inch Increments from 36" to 84"
- Legs Required – Assembly Required
- Tops 60" and Larger Include Stiffener Bar
- Pre-Drilled for Ganging Brackets

What You Need – Leg Assembly *(Not Available to be Sold Separately)*
Envy Post Leg

	Weight	Cubes	List Price
08-0227APL4	20	1.6	\$ 513
Set of 4			

Vantage Post Leg

	Weight	Cubes	List Price
08-0227SPL4	20	1.6	\$ 415
Set of 4			

Description

- Adjustable Glides

Options: Specify & Add
Ganging

08-1505GB	Ganging Bracket Kit – Set of 2 with Thumb Screws	\$ 48
-----------	--	-------

Modesty Panel
Fixed – Use with 30" Trapezoids

	For	List Price
85-FLEXMDTRP30	84 - 73	W\$ 679 CV\$ 713
	72 - 61	W\$ 614 CV\$ 645
	60 - 49	W\$ 577 CV\$ 606
	48 - 36	W\$ 543 CV\$ 570

Fixed – Use with 24" Trapezoids

	For	List Price
85-FLEXMDTRP24	84 - 73	W\$ 666 CV\$ 699
	72 - 61	W\$ 599 CV\$ 629
	60 - 49	W\$ 565 CV\$ 593
	48 - 36	W\$ 530 CV\$ 557

- Also Available in Laminate, See Laminate Price List

Power & Data

See Pages 92 – 97 for Power and Data Options

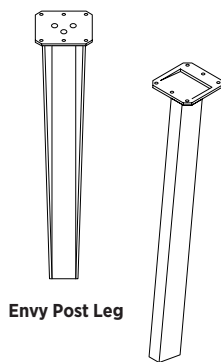

Envy Post Leg

Vantage Post Leg

Tri-One™ Series – Veneer
 Multi-Use Tables – Knife Edge

Item	Model No.	W	D	H	Ship Wt	Cubic Ft	List Price
PENTAGON MODULAR CONFERENCE TOP KNIFE EDGE	85-30MCTPK	58 - 48 $\frac{5}{8}$	18 - 25	—	44	3.6	W\$ 953 CV\$ 1001

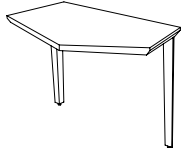

For Use with 30" Modular Tops

85-24MCTPK	46 $\frac{1}{2}$ - 37	18 - 23 $\frac{1}{2}$	—	33.7	3.6	W\$ 842 CV\$ 884
------------	-----------------------	-----------------------	---	------	-----	---------------------

For Use with 24" Modular Tops

Description

- Not a Freestanding Table
- Pre-Drilled for Ganging Brackets
- Legs Required – Assembly Required
- Ganging Brackets Required

What You Need – Leg Assembly *(Not Available to be Sold Separately)*
Envy Post Leg

	Weight	Cubes	List Price
08-0227APL2	10	0.8	\$ 294
Set of 2			

Vantage Post Leg

	Weight	Cubes	List Price
08-0227SPL2	10	0.8	\$ 245
Set of 2			

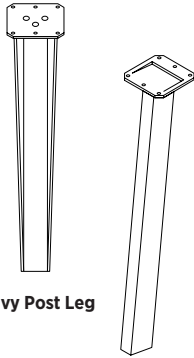

Envy Post Leg

Vantage Post Leg



Description

- Adjustable Glides

Options: Specify & Add
Ganging – Requires 2 Sets

08-1505GB	Ganging Bracket Kit – Set of 2 with Thumb Screws	\$ 48
-----------	--	-------

Tri-One™ Series – Veneer
 Multi-Use Tables – Knife Edge

Item	Model No.	W	D	H	Ship Wt	Cubic Ft	List Price	
BRIDGE MODULAR CONFERENCE TOP KNIFE EDGE 	85-3090MCTBK	42 $\frac{1}{2}$	30	—	18.2	2	W\$ 1064 CV\$ 1117	
	For Use with 30" Modular Tops							
	85-2490MCTBK	34	24	—	11.6	1.3	W\$ 752 CV\$ 790	
For Use with 24" Modular Tops								
Description								
<ul style="list-style-type: none"> • 90° Bridge Conference Top with Knife Edge • Connects Two Conference Tops • Pre-Drilled for Ganging Brackets • Not a Freestanding Unit • Ganging Brackets Required 								
Options: Specify & Add								
Ganging – Requires 2 Sets								
08-1505GB	Ganging Bracket Kit – Set of 2 with Thumb Screws						\$ 48	
BRIDGE MODULAR CONFERENCE TOP KNIFE EDGE 	85-3045MCTBK	27 $\frac{1}{2}$	30	—	16.1	2	W\$ 772 CV\$ 811	
	For Use with 30" Modular Tops							
	85-2445MCTBK	22 $\frac{1}{2}$	24	—	10.8	1.4	W\$ 689 CV\$ 723	
For Use with 24" Modular Tops								
Description								
<ul style="list-style-type: none"> • 45° Bridge Conference Top with Knife Edge • Connects Two Conference Tops • Pre-Drilled for Ganging Brackets • Not a Freestanding Unit • Ganging Brackets Required 								
Options: Specify & Add								
Ganging – Requires 2 Sets								
08-1505GB	Ganging Bracket Kit – Set of 2 with Thumb Screws						\$ 48	
BRIDGE MODULAR CONFERENCE TOP KNIFE EDGE 	85-3030MCTBK	19 $\frac{3}{4}$	30	—	11.4	1.5	W\$ 723 CV\$ 759	
	For Use with 30" Modular Tops							
	85-2430MCTBK	16 $\frac{3}{4}$	24	—	8.6	1.1	W\$ 655 CV\$ 688	
For Use with 24" Modular Tops								
Description								
<ul style="list-style-type: none"> • 30° Bridge Conference Top with Knife Edge • Connects Two Conference Tops • Pre-Drilled for Ganging Brackets • Not a Freestanding Unit • Ganging Brackets Required 								
Options: Specify & Add								
Ganging – Requires 2 Sets								
08-1505GB	Ganging Bracket Kit – Set of 2 with Thumb Screws						\$ 48	

Tri-One™ Series – Veneer
 Multi-Use Tables – Knife Edge

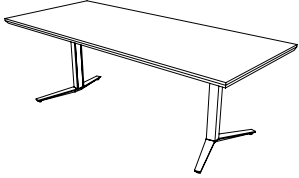
Item	Model No.	W	D	H	Ship Wt	Cubic Ft	List Price	
 RECTANGULAR MEETING TABLES KNIFE EDGE	85-4296MTK	96	42	—	122.2	9.4	W\$ 1801 CV\$ 1891	
	55" Kneespace							
	85-4284MTK	84	42	—	106.9	8.2	W\$ 1690 CV\$ 1775	
	47" Kneespace							
	85-4272MTK	72	42	—	91.7	7.1	W\$ 1502 CV\$ 1577	
	39" Kneespace							
	85-4260MTK	60	42	—	76.4	5.7	W\$ 1377 CV\$ 1446	
	31½" Kneespace							
	85-3696MTK	96	36	—	104.8	8.1	W\$ 1625 CV\$ 1706	
	55" Kneespace							
85-3684MTK	84	36	—	92	7.1	W\$ 1512 CV\$ 1588		
47" Kneespace								
85-3672MTK	72	36	—	78.6	6.1	W\$ 1376 CV\$ 1445		
39" Kneespace								
85-3660MTK	60	36	—	65.5	5.1	W\$ 1265 CV\$ 1328		
31½" Kneespace								

Description

- Seated Height Bases Required – Assembly Required

What You Need – Base (Not Available to be Sold Separately)
X-Base (2 Bases Required)

	Weight	Cubes	List Price
08-2630LXB	27	14.5	\$ 724

Y-Base

	Weight	Cubes	List Price
08-2828YLG96 For 96" Tables	47	6.5	\$ 1030
08-2828YLG84 For 84" Tables	43	5.4	\$ 1016
08-2828YLG72 For 72" Tables	39	4.3	\$ 994
08-2828YLG60 For 60" Tables	35	3.2	\$ 955

Power & Data

See Pages 92 – 97 for Power and Data Options

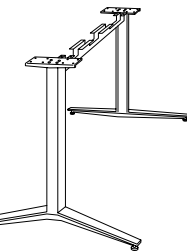
X-Base Detail

Y-Base Detail

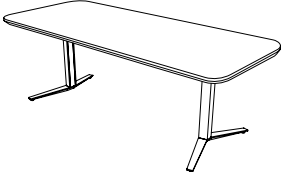
Tri-One™ Series – Veneer
 Multi-Use Tables – Knife Edge

Item	Model No.	W	D	H	Ship Wt	Cubic Ft	List Price
 SOFT RECTANGULAR MEETING TABLES KNIFE EDGE	85-4296SMTK	96	42	—	122.2	9.4	W\$ 1739 CV\$ 1826
	55" Kneespace 85-4284SMTK	84	42	—	106.9	8.2	W\$ 1636 CV\$ 1718
	47" Kneespace 85-4272SMTK	72	42	—	91.7	7.1	W\$ 1453 CV\$ 1526
	39" Kneespace 85-4260SMTK	60	42	—	76.4	5.7	W\$ 1336 CV\$ 1403
	31½" Kneespace 85-3696SMTK	96	36	—	104.8	8.1	W\$ 1565 CV\$ 1643
	55" Kneespace 85-3684SMTK	84	36	—	92	7.1	W\$ 1460 CV\$ 1533
	47" Kneespace 85-3672SMTK	72	36	—	78.6	6.1	W\$ 1331 CV\$ 1398
	39" Kneespace 85-3660SMTK	60	36	—	65.5	5.1	W\$ 1226 CV\$ 1287
	31½" Kneespace						

Description

- Seated Height Bases Required – Assembly Required

What You Need – Base (Not Available to be Sold Separately)
X-Base (2 Bases Required)

	Weight	Cubes	List Price
08-2630LXB	27	14.5	\$ 724

Y-Base

	Weight	Cubes	List Price
08-2828YLG96 For 96" Tables	47	6.5	\$ 1030
08-2828YLG84 For 84" Tables	43	5.4	\$ 1016
08-2828YLG72 For 72" Tables	39	4.3	\$ 994
08-2828YLG60 For 60" Tables	35	3.2	\$ 955

Power & Data

See Pages 92 – 97 for Power and Data Options

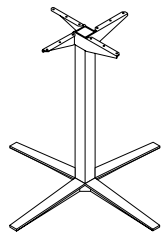

X-Base Detail

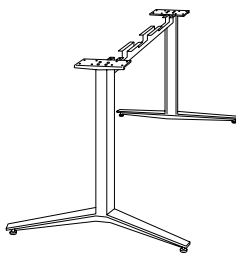

Y-Base Detail

Tri-One™ Series – Veneer
 Multi-Use Tables – Knife Edge

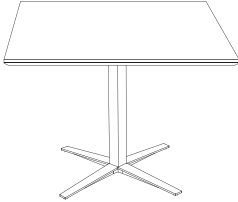
Item	Model No.	W	D	H	Ship Wt	Cubic Ft	List Price
SQUARE MEETING TABLES KNIFE EDGE 	85-4242SQK	42	42	—	70	3.3	W\$ 1057 CV\$ 1110
	85-3636SQK	36	36	—	37	2.5	W\$ 903 CV\$ 948
	85-3030SQK	30	30	—	30	2.2	W\$ 793 CV\$ 833

Description

- Bases Required – Assembly Required

What You Need – Base *(Not Available to be Sold Separately)*
Large X-Base – For Use with 42"

	Weight	Cubes	List Price
08-2642LXB 42" High Tables	35%	35%	40 \$ 785
08-2636LXB 36" High Tables	35%	35%	34 \$ 756
08-2630LXB 30" High Tables	35%	35%	28 \$ 724

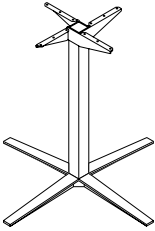
Large X-Base Detail
Small X-Base – For Use with 36" and 30"

	Weight	Cubes	List Price
08-2042SXB 42" High Tables	29%	29%	40 \$ 732
08-2036SXB 36" High Tables	29%	29%	34 \$ 704
08-2030SXB 30" High Tables	29%	29%	28 \$ 675

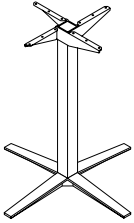
Small X-Base Detail

Tri-One™ Series – Veneer
 Multi-Use Tables – Knife Edge

Item	Model No.	W	D	H	Ship Wt	Cubic Ft	List Price
SOFT SQUARE MEETING TABLES KNIFE EDGE	85-4242SSQK	42	42	—	70	3.3	W\$ 1022 CV\$ 1073



85-3636SSQK	36	36	—	37	2.5	W\$ 876 CV\$ 920
-------------	----	----	---	----	-----	---------------------

85-3030SSQK	30	30	—	30	2.2	W\$ 776 CV\$ 815
-------------	----	----	---	----	-----	---------------------

Description

- Bases Required – Assembly Required

What You Need – Base *(Not Available to be Sold Separately)*
Large X-Base – For Use with 42"

	Weight	Cubes	List Price
08-2642LXB 42" High Tables	35%	35%	40 \$ 785
08-2636LXB 36" High Tables	35%	35%	34 \$ 756
08-2630LXB 30" High Tables	35%	35%	28 \$ 724

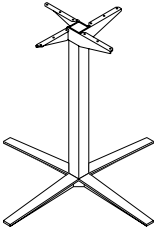
Large X-Base Detail
Small X-Base – For Use with 36" and 30"

	Weight	Cubes	List Price
08-2042SXB 42" High Tables	29%	29%	40 \$ 732
08-2036SXB 36" High Tables	29%	29%	34 \$ 704
08-2030SXB 30" High Tables	29%	29%	28 \$ 675

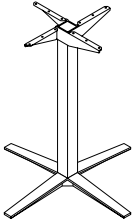
Small X-Base Detail

Tri-One™ Series – Veneer
 Multi-Use Tables – Knife Edge

Item	Model No.	W	D	H	Ship Wt	Cubic Ft	List Price
ROUND MEETING TABLES KNIFE EDGE	85-4848CTK	48	48	—	95	4.3	W\$ 1143 CV\$ 1200
	85-4242CTK	42	42	—	70	3.3	W\$ 993 CV\$ 1043
	85-3636CTK	36	36	—	37	2.5	W\$ 869 CV\$ 912
	85-3030CTK	30	30	—	30	2.2	W\$ 767 CV\$ 805

Description

- Bases Required – Assembly Required

What You Need – Base *(Not Available to be Sold Separately)*
Large X-Base – For Use with 48" and 42"

	Weight	Cubes	List Price
08-2642LXB 42" High Tables	35%	20	\$ 785
08-2636LXB 36" High Tables	35%	17.2	\$ 756
08-2630LXB 30" High Tables	35%	14.5	\$ 724

Small X-Base – For Use with 36" and 30"

	Weight	Cubes	List Price
08-2042SXB 42" High Tables	29%	15.9	\$ 732
08-2036SXB 36" High Tables	29%	13.7	\$ 704
08-2030SXB 30" High Tables	29%	11.6	\$ 675

Large X-Base Detail

Small X-Base Detail

Tri-One™ Series – Veneer
 Multi-Use Tables – Knife Edge

Item	Model No.	W	D	H	Ship Wt	Cubic Ft	List Price
SOFT VIEW MEETING TABLES KNIFE EDGE	85-4296SVTK	96	42 - 36	—	122.2	9.4	W\$ 1730 CV\$ 1817
	85-4284SVTK	84	42 - 36	—	106.9	8.2	W\$ 1564 CV\$ 1642
	85-4272SVTK	72	42 - 36	—	91.7	7.1	W\$ 1452 CV\$ 1525

Description

- Seated Height Bases Required – Assembly Required

What You Need – Base *(Not Available to be Sold Separately)*
X-Base (2 Bases Required)

	Weight	Cubes	List Price
08-2630LXB	27	14.5	\$ 724

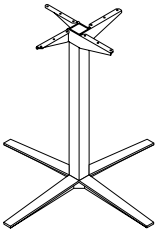

X-Base Detail

Y-Base

	Weight	Cubes	List Price
08-2828YLG96 For 96" Tables	47	6.5	\$ 1030
08-2828YLG84 For 84" Tables	43	5.4	\$ 1016
08-2828YLG72 For 72" Tables	39	4.3	\$ 994
08-2828YLG60 For 60" Tables	35	3.2	\$ 955

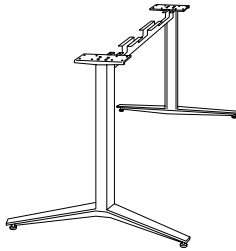

Y-Base Detail

Power & Data

See Pages 92 – 97 for Power and Data Options

Tri-One™ Series – Veneer
 Multi-Use Tables – Knife Edge

Item	Model No.	W	D	H	Ship Wt	Cubic Ft	List Price
ELLIPSE MEETING TABLES KNIFE EDGE	85-4284EMTK	84	48	—	106.9	8.2	W\$ 1621 CV\$ 1702



	85-3672EMTK	72	30	—	78.6	6.1	W\$ 1318 CV\$ 1384
--	-------------	----	----	---	------	-----	-----------------------

Description

- Includes Stiffener Bar
- Base Required – Assembly Required

What You Need – Leg Assembly *(Not Available to be Sold Separately)*
Envy Post Leg

	Weight	Cubes	List Price
08-0227APL4	20	1.6	\$ 513
Set of 4			

Vantage Post Leg

	Weight	Cubes	List Price
08-0227SPL4	20	1.6	\$ 415
Set of 4			

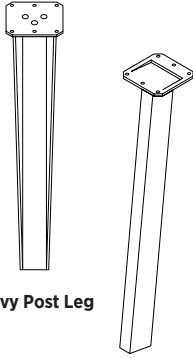

Envy Post Leg

Vantage Post Leg

Description

- Choose from Envy Post Leg or Vantage Post Leg
- Adjustable Glides
- Assembly Required

Power & Data

See Pages 92 – 97 for Power and Data Options

Tri-One™ Laminate

Multi-Use Table Collection

Square Edge

How to Order

	QTY	MODEL NO.	DESCRIPTION	
TOP	10	86-1872TTH 08-FLIP	Laminate Color Flip Mechanism	HM
BASE	10	08-1828CLC72	Optional Caster	Soft Caster
DATA	10	01-PDUUNDERW		
	2	01-PPOWER		
	5	01-2JUMP		



Specifications

TOPS

Tops are 1" thick thermally-fused laminate (TFL) or 1-3/16" high-pressure laminate (HPL) fused to particle-board core. Select from solid color, patterned, and wood-grained laminates, including textured laminates. A Square Edge (Y) profile is available on TFL and HPL standard laminates with a 3mm PVC rim. The Square Edge (H) profile on Textured TFL and HPL is 1mm. Training and Modular Conference tops feature shaped profiles on the user side while meeting tables are shaped on four sides. Tops are pre-drilled for the specified base assembly and for ganging where applicable.

LEG ASSEMBLY

All leg styles are powder-coated aluminum and include a 5mm steel mounting plate. Envy style legs are aluminum extrusion while Vantage style legs are steel welded. Envy C-Legs and Envy Y-Legs include troughs which act as modesty panels and route cables cleanly to the legs where a removable panel provides access. Vantage T-Legs are equipped with a stretcher rail for secure support. All legs include adjustable glides or casters.

FLIP MECHANISM

Indiana Furniture's training tables offer an exclusive flip mechanism design which can be accessed from any position. Optional flip mechanisms are factory installed and must be specified at the time of order.

GANGING

All training tables and modular conference tables are pre-drilled with threaded inserts for ganging applications. Ganging brackets include quick release thumb screws for ease of use. No tools required.

POWER PORTS

Power ports are available for under-surface mount or routed into work surfaces. Units comply with FCC Part 15A and UL. Both standard plugs and daisy-chain connections are offered. Daisy chain applications are non-sequential and connect up to 8 modules.



Laminate Options

STANDARD TFL (T) - MUST SPECIFY

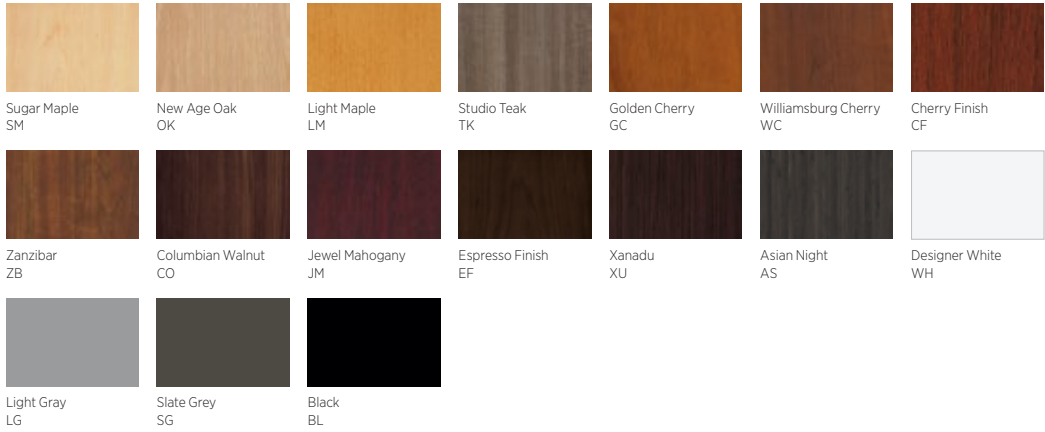

STANDARD HPL (P) OPTIONS - MUST SPECIFY

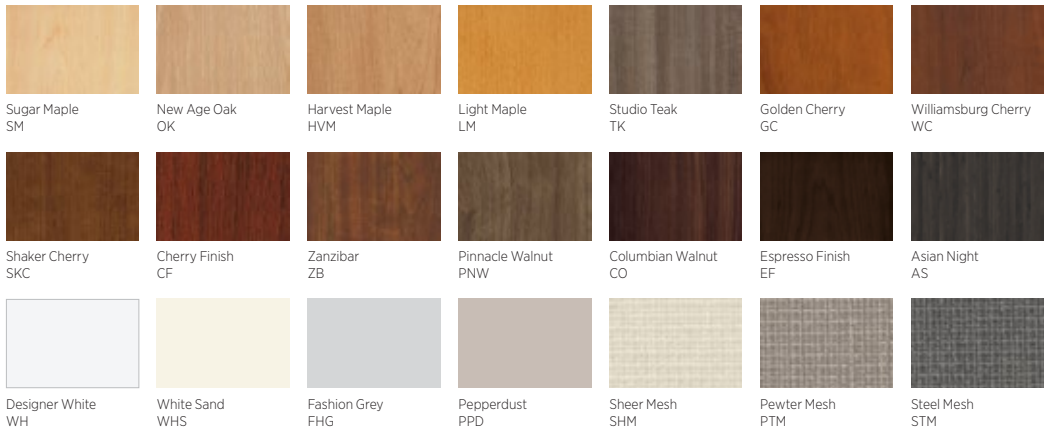

TEXTURED TFL (TXT) AND HPL (TXP) OPTIONS - MUST SPECIFY

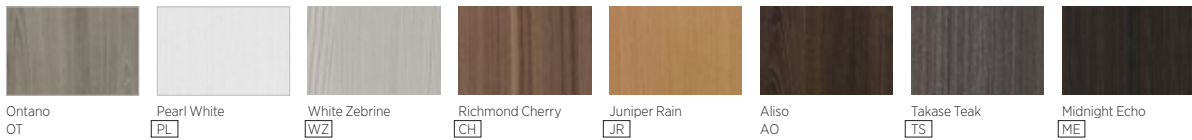

Available in High Pressure Laminate Tops. (P)

Edge Options



Square
Y/H

Textured TXT and TXP options are available with H square edge only.
Standard HPL and TFL options are available with Y square edge only.

WIRE MANAGEMENT GROMMET

Optional black grommets are available in Training Tables and Modular Conference Tops. Please specify any combination of Left, Right, and Center and add \$47 list for each grommet.

Specify & Add: GL – Grommet Left
 GR – Grommet Right
 GC – Grommet Center

Grommets may be ordered in non-standard locations. Please call Customer Service to assist with how to order and additional lead time requirements.

18" Training Tables



GL/GR – 10" from end, 12" from user side
 GC – Grommet Center – 12" from user side

24" Training Tables

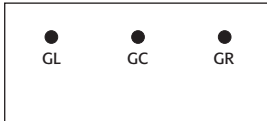

GL/GR – 10" from end, 16.5" from user side
 GC – Grommet Center – 16.5" from user side

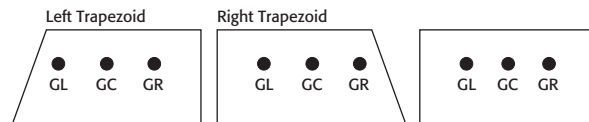
30" Training Tables

GL/GR – 10" from end, 20" from user side
 GC – Grommet Center – 20" from user side

24" Modular Conference Tables

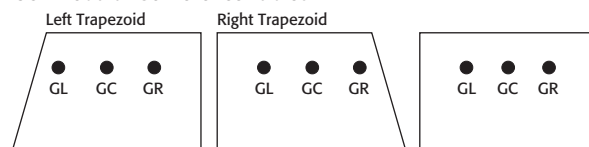
GL/GR – 10" from end based on widest dimension, 13 3/8" from user side
 GC – Grommet Center – 13 3/8" from user side

30" Modular Conference Tables

GL/GR – 10" from end based on widest dimension, 19 3/8" from user side
 GC – Grommet Center – 19 3/8" from user side

POWER ACCESSORIES

Indiana Furniture offers Power Accessories for training tables, modular conference tops, and rectangular, ellipse or view meeting tables that can be mounted below the worksurface or in the worksurface top. Power Accessories that include a bezel frame will be routed for field placement at no additional charge. See pages 92-97 to specify and order Power Accessories.

Power Accessories will be routed on center, left to right:

- 18" Training Tables – 12" from user side
- 24" Training Tables – 16.5" from user side
- 30" Training Tables – 20" from user side
- 24" Modular Conference Tables – 13 3/8" from user side
- 30" Modular Conference Tables – 19 3/8" from user side
- Meeting Tables – On center, front to back

Tri-One™ Series – Laminate
 Multi-Use Tables – Square Edge

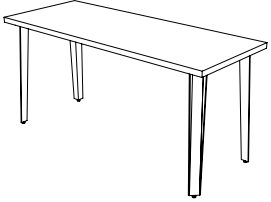
Item	Model No.		W	D	H	Ship Wt	Cubic Ft	List Price
RECTANGULAR MODULAR CONFERENCE TOP SQUARE EDGE 	TFL	HPL						
	86-3084MCT	86-3084MCTH	84	30	—	76.4	6	T\$ 639 P\$ 866 TXT\$ 773 TXP\$ 935
	86-3072MCT	86-3072MCTH	72	30	—	65.5	5.1	T\$ 518 P\$ 702 TXT\$ 627 TXP\$ 758
	86-3060MCT	86-3060MCTH	60	30	—	54.6	4.3	T\$ 465 P\$ 630 TXT\$ 563 TXP\$ 680
	86-3048MCT	86-3048MCTH	48	30	—	43.7	3.5	T\$ 348 P\$ 472 TXT\$ 421 TXP\$ 510
	86-2484MCT	86-2484MCTH	84	24	—	61.1	4.9	T\$ 594 P\$ 805 TXT\$ 719 TXP\$ 869
	86-2472MCT	86-2472MCTH	72	24	—	52.4	4.2	T\$ 478 P\$ 648 TXT\$ 578 TXP\$ 700
	86-2460MCT	86-2460MCTH	60	24	—	43.7	3.5	T\$ 434 P\$ 588 TXT\$ 525 TXP\$ 635
	86-2448MCT	86-2448MCTH	48	24	—	34.9	2.8	T\$ 322 P\$ 436 TXT\$ 390 TXP\$ 471

Description

- Flexible Sizes Available, See Page 47
- Legs Required – Assembly Required
- Pre-Drilled for Ganging Brackets
- Tops 60" and Larger Include Stiffener Bar

What You Need – Leg Assembly *(Not Available to be Sold Separately)*
Envy Post Leg

	Weight	Cubes	List Price
08-0227APL4	20	1.6	\$ 513
Set of 4			

Vantage Post Leg

	Weight	Cubes	List Price
08-0227SPL4	20	1.6	\$ 415
Set of 4			



Envy Post Leg

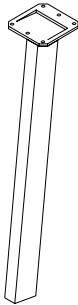

Vantage Post Leg

Description

- Adjustable Glides

Options: Specify & Add
Ganging

08-1505GB	Ganging Bracket Kit – Set of 2 with Thumb Screws	\$ 48
-----------	--	-------

Modesty Panel
Fixed

	For	List Price
TFL: 86-0884MD	84	T\$ 321 TXT\$ 388
HPL: 86-0884MDH		P\$ 435 TXP\$ 470
TFL: 86-0872MD	72	T\$ 312 TXT\$ 378
HPL: 86-0872MDH		P\$ 423 TXP\$ 457
TFL: 86-0860MD	60	T\$ 294 TXT\$ 356
HPL: 86-0860MDH		P\$ 398 TXP\$ 430
TFL: 86-0848MD	48	T\$ 285 TXT\$ 345
HPL: 86-0848MDH		P\$ 386 TXP\$ 417

Power & Data

See Pages 92 – 97 for Power and Data Options

Tri-One™ Series – Laminate
 Multi-Use Tables – Square Edge

Item	Model No.	W	D	H	Ship Wt	Cubic Ft	List Price	
RECTANGULAR MODULAR CONFERENCE TOP SQUARE EDGE - FLEXIBLE SIZES	TFL	HPL						
	86-FLEXMCT30	86-FLEXMCTH30	84 - 73	30	—	76.4	6	T\$ 639 P\$ 866 TXT\$ 773 TXP\$ 935
			72 - 61	30	—	65.5	5.1	T\$ 518 P\$ 702 TXT\$ 627 TXP\$ 758
			60 - 49	30	—	54.6	4.3	T\$ 465 P\$ 630 TXT\$ 563 TXP\$ 680
			48 - 36	30	—	43.7	3.5	T\$ 348 P\$ 472 TXT\$ 421 TXP\$ 510
	86-FLEXMCT24	86-FLEXMCTH24	84 - 73	24	—	61.1	4.9	T\$ 594 P\$ 805 TXT\$ 719 TXP\$ 869
			72 - 61	24	—	52.4	4.2	T\$ 478 P\$ 648 TXT\$ 578 TXP\$ 700
			60 - 49	24	—	43.7	3.5	T\$ 434 P\$ 588 TXT\$ 525 TXP\$ 635
			48 - 36	24	—	34.9	2.8	T\$ 322 P\$ 436 TXT\$ 390 TXP\$ 471

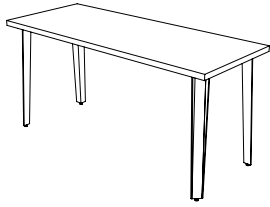
Description

- Must Specify Width In One Inch Increments from 36" to 84"
- Legs Required – Assembly Required
- Tops 60" and Larger Include Stiffener Bar
- Pre-Drilled for Ganging Brackets

What You Need – Leg Assembly *(Not Available to be Sold Separately)*
Envy Post Leg

	Weight	Cubes	List Price
08-0227APL4	20	1.6	\$ 513
Set of 4			

Vantage Post Leg

	Weight	Cubes	List Price
08-0227SPL4	20	1.6	\$ 415
Set of 4			



Envy Post Leg

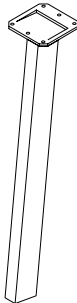

Vantage Post Leg

Description

- Adjustable Guides

Options: Specify & Add
Ganging

08-1505GB	Ganging Bracket Kit – Set of 2 with Thumb Screws	\$ 48
-----------	--	-------

Modesty Panel - Order Modesty to Match Top Size. Unit Will Fit Approach Side



Fixed

	For	List Price
TFL: 86-FLEXMD	84 - 73	T\$ 321 TXT\$ 388
HPL: 86-FLEXMDH		P\$ 435 TXP\$ 470
	72 - 61	T\$ 312 TXT\$ 378
		P\$ 423 TXP\$ 457
	60 - 49	T\$ 294 TXT\$ 356
		P\$ 398 TXP\$ 430
	48 - 36	T\$ 285 TXT\$ 345
		P\$ 386 TXP\$ 417

Power & Data

See Pages 92 – 97 for Power and Data Options

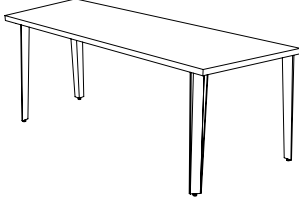
Tri-One™ Series – Laminate
 Multi-Use Tables – Square Edge

Item	Model No.		W	D	H	Ship Wt	Cubic Ft	List Price
LEFT TRAPEZOID MODULAR CONFERENCE TOP SQUARE EDGE	TFL	HPL						
	86-3084LMCT	86-3084LMCTH	84	30	—	76.4	6	T\$ 614 P\$ 832 TXT\$ 743 TXP\$ 899
	86-3072LMCT	86-3072LMCTH	72	30	—	65.5	5.1	T\$ 496 P\$ 672 TXT\$ 600 TXP\$ 762
	86-3060LMCT	86-3060LMCTH	60	30	—	54.6	4.3	T\$ 447 P\$ 606 TXT\$ 541 TXP\$ 654
 User Side	86-3048LMCT	86-3048LMCTH	48	30	—	43.7	3.5	T\$ 334 P\$ 453 TXT\$ 404 TXP\$ 489
	86-2484LMCT	86-2484LMCTH	84	24	—	61.1	4.9	T\$ 571 P\$ 774 TXT\$ 691 TXP\$ 836
	86-2472LMCT	86-2472LMCTH	72	24	—	52.4	4.2	T\$ 458 P\$ 621 TXT\$ 554 TXP\$ 671
	86-2460LMCT	86-2460LMCTH	60	24	—	43.7	3.5	T\$ 417 P\$ 565 TXT\$ 505 TXP\$ 610
	86-2448LMCT	86-2448LMCTH	48	24	—	34.9	2.8	T\$ 307 P\$ 416 TXT\$ 371 TXP\$ 449

Description

- Flexible Sizes Available, See Page 49
- Legs Required – Assembly Required
- Pre-Drilled for Ganging Brackets
- Tops 60" and Larger Include Stiffener Bar

What You Need – Leg Assembly *(Not Available to be Sold Separately)*
Envy Post Leg

	Weight	Cubes	List Price
08-0227APL4	20	1.6	\$ 513
Set of 4			

Vantage Post Leg

	Weight	Cubes	List Price
08-0227SPL4	20	1.6	\$ 415
Set of 4			



Envy Post Leg

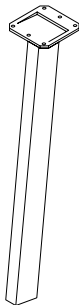

Vantage Post Leg

Description

- Adjustable Glides

Options: Specify & Add
Ganging

08-1505GB	Ganging Bracket Kit – Set of 2 with Thumb Screws	\$ 48
-----------	--	-------

Modesty Panel
Fixed – Use with 30" Trapezoids

	For	List Price
TFL: 86-0884MDT30	84	T\$ 339 TXT\$ 410
HPL: 86-0884MDTH30		P\$ 459 TXP\$ 496
TFL: 86-0872MDT30	72	T\$ 306 TXT\$ 370
HPL: 86-0872MDTH30		P\$ 415 TXP\$ 448
TFL: 86-0860MDT30	60	T\$ 288 TXT\$ 348
HPL: 86-0860MDTH30		P\$ 390 TXP\$ 421
TFL: 86-0848MDT30	48	T\$ 271 TXT\$ 328
HPL: 86-0848MDTH30		P\$ 367 TXP\$ 396

Fixed – Use with 24" Trapezoids

	For	List Price
TFL: 86-0884MDT24	84	T\$ 332 TXT\$ 402
HPL: 86-0884MDTH24		P\$ 450 TXP\$ 486
TFL: 86-0872MDT24	72	T\$ 299 TXT\$ 362
HPL: 86-0872MDTH24		P\$ 405 TXP\$ 437
TFL: 86-0860MDT24	60	T\$ 282 TXT\$ 341
HPL: 86-0860MDTH24		P\$ 382 TXP\$ 413
TFL: 86-0848MDT24	48	T\$ 264 TXT\$ 319
HPL: 86-0848MDTH24		P\$ 358 TXP\$ 387

Power & Data

See Pages 92 – 97 for Power and Data Options

Tri-One™ Series – Laminate
Multi-Use Tables – Square Edge

Item	Model No.	W	D	H	Ship Wt	Cubic Ft	List Price
LEFT TRAPEZOID MODULAR CONFERENCE TOP SQUARE EDGE	TFL	HPL					
	86-FLEXLMCT30	86-FLEXLMCTH30	84 - 73	30	—	76.4	6
							T\$ 614
							P\$ 832
							TXT\$ 743
							TXP\$ 899
			72 - 61	30	—	65.5	5.1
							T\$ 496
							P\$ 672
							TXT\$ 600
							TXP\$ 762
			60 - 49	30	—	54.6	4.3
						T\$ 447	
						P\$ 606	
						TXT\$ 541	
						TXP\$ 654	
		48 - 36	30	—	43.7	3.5	
						T\$ 334	
						P\$ 453	
						TXT\$ 404	
						TXP\$ 489	
	86-FLEXLMCT24	86-FLEXLMCTH24	84 - 73	24	—	61.1	4.9
							T\$ 571
							P\$ 774
							TXT\$ 691
							TXP\$ 836
			72 - 61	24	—	52.4	4.2
							T\$ 458
							P\$ 621
							TXT\$ 554
							TXP\$ 671
			60 - 49	24	—	43.7	3.5
							T\$ 417
							P\$ 565
							TXT\$ 505
							TXP\$ 610
			48 - 36	24	—	34.9	2.8
							T\$ 307
							P\$ 416
							TXT\$ 371
							TXP\$ 449

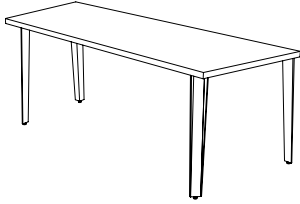

User Side

Description

- Must Specify Width In One Inch Increments from 36" to 84"
- Legs Required – Assembly Required
- Tops 60" and Larger Include Stiffener Bar
- Pre-Drilled for Ganging Brackets

What You Need – Leg Assembly (Not Available to be Sold Separately)

Envy Post Leg

	Weight	Cubes	List Price
08-0227APL4	20	1.6	\$ 513
Set of 4			

Vantage Post Leg

	Weight	Cubes	List Price
08-0227SPL4	20	1.6	\$ 415
Set of 4			



Envy Post Leg

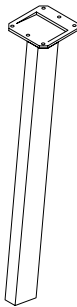

Vantage Post Leg

Description

- Adjustable Glides

Options: Specify & Add
Ganging

08-1505GB	Ganging Bracket Kit – Set of 2 with Thumb Screws	\$ 48
-----------	--	-------

Modesty Panel - Order Modesty to Match Top Size. Unit Will Fit Approach Side

Fixed – Use with 30" Trapezoids

	For	List Price
TFL: 86-FLEXMDTRP30	84 - 73 T\$ 339 TXT\$ 410	
HPL: 86-FLEXMDTRP30H	P\$ 459 TXP\$ 496	
	72 - 61 T\$ 306 TXT\$ 370	
	P\$ 415 TXP\$ 448	
	60 - 49 T\$ 288 TXT\$ 348	
	P\$ 390 TXP\$ 421	
	48 - 36 T\$ 271 TXT\$ 328	
	P\$ 367 TXP\$ 396	

Fixed – Use with 24" Trapezoids

	For	List Price
TFL: 86-FLEXMDTRP24	84 - 73 T\$ 332 TXT\$ 402	
HPL: 86-FLEXMDTRP24H	P\$ 450 TXP\$ 486	
	72 - 61 T\$ 299 TXT\$ 362	
	P\$ 405 TXP\$ 437	
	60 - 49 T\$ 282 TXT\$ 341	
	P\$ 382 TXP\$ 413	
	48 - 36 T\$ 264 TXT\$ 319	
	P\$ 358 TXP\$ 387	

Power & Data

See Pages 92 – 97 for Power and Data Options

Tri-One™ Series – Laminate
 Multi-Use Tables – Square Edge

Item	Model No.	W	D	H	Ship Wt	Cubic Ft	List Price	
RIGHT TRAPEZOID MODULAR CONFERENCE TOP SQUARE EDGE	TFL	HPL						
	86-3084RMCT	86-3084RMCTH	84	30	—	76.4	6	T\$ 614 P\$ 832 TXT\$ 743 TXP\$ 899
	86-3072RMCT	86-3072RMCTH	72	30	—	65.5	5.1	T\$ 496 P\$ 672 TXT\$ 600 TXP\$ 762
	86-3060RMCT	86-3060RMCTH	60	30	—	54.6	4.3	T\$ 447 P\$ 606 TXT\$ 541 TXP\$ 654
	86-3048RMCT	86-3048RMCTH	48	30	—	43.7	3.5	T\$ 334 P\$ 453 TXT\$ 404 TXP\$ 489
	86-2484RMCT	86-2484RMCTH	84	24	—	61.1	4.9	T\$ 571 P\$ 774 TXT\$ 691 TXP\$ 836
	86-2472RMCT	86-2472RMCTH	72	24	—	52.4	4.2	T\$ 458 P\$ 621 TXT\$ 554 TXP\$ 671
	86-2460RMCT	86-2460RMCTH	60	24	—	43.7	3.5	T\$ 417 P\$ 565 TXT\$ 505 TXP\$ 610
	86-2448RMCT	86-2448RMCTH	48	24	—	34.9	2.8	T\$ 307 P\$ 416 TXT\$ 371 TXP\$ 449

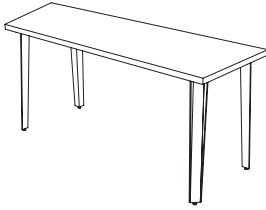

User Side

Description

- Flexible Sizes Available, See Page 51
- Legs Required – Assembly Required
- Pre-Drilled for Ganging Brackets
- Tops 60" and Larger Include Stiffener Bar

What You Need – Leg Assembly *(Not Available to be Sold Separately)*
Envy Post Leg

	Weight	Cubes	List Price
08-0227APL4	20	1.6	\$ 513
Set of 4			

Vantage Post Leg

	Weight	Cubes	List Price
08-0227SPL4	20	1.6	\$ 415
Set of 4			



Envy Post Leg

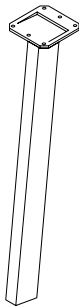

Vantage Post Leg

Description

- Adjustable Glides

Options: Specify & Add
Ganging

08-1505GB	Ganging Bracket Kit – Set of 2 with Thumb Screws	\$ 48
-----------	--	-------

Modesty Panel
Fixed – Use with 30" Trapezoids

	For	List Price
TFL: 86-0884MDT30	84	T\$ 339 TXT\$ 410
HPL: 86-0884MDTH30		P\$ 459 TXP\$ 496
TFL: 86-0872MDT30	72	T\$ 306 TXT\$ 370
HPL: 86-0872MDTH30		P\$ 415 TXP\$ 448
TFL: 86-0860MDT30	60	T\$ 288 TXT\$ 348
HPL: 86-0860MDTH30		P\$ 390 TXP\$ 421
TFL: 86-0848MDT30	48	T\$ 271 TXT\$ 328
HPL: 86-0848MDTH30		P\$ 367 TXP\$ 396

Fixed – Use with 24" Trapezoids

	For	List Price
TFL: 86-0884MDT24	84	T\$ 332 TXT\$ 402
HPL: 86-0884MDTH24		P\$ 450 TXP\$ 486
TFL: 86-0872MDT24	72	T\$ 299 TXT\$ 362
HPL: 86-0872MDTH24		P\$ 405 TXP\$ 437
TFL: 86-0860MDT24	60	T\$ 282 TXT\$ 341
HPL: 86-0860MDTH24		P\$ 382 TXP\$ 413
TFL: 86-0848MDT24	48	T\$ 264 TXT\$ 319
HPL: 86-0848MDTH24		P\$ 358 TXP\$ 387

Power & Data

See Pages 92 – 97 for Power and Data Options

Tri-One™ Series – Laminate
 Multi-Use Tables – Square Edge

Item	Model No.	W	D	H	Ship Wt	Cubic Ft	List Price
RIGHT TRAPEZOID MODULAR CONFERENCE TOP SQUARE EDGE	TFL	HPL					
	86-FLEXRMCT30	86-FLEXRMCTH30	84 - 73	30	—	76.4	6
							T\$ 614
							P\$ 832
							TXT\$ 743
							TXP\$ 899
			72 - 61	30	—	65.5	5.1
							T\$ 496
							P\$ 672
							TXT\$ 600
							TXP\$ 762
			60 - 49	30	—	54.6	4.3
						T\$ 447	
						P\$ 606	
						TXT\$ 541	
						TXP\$ 654	
		48 - 36	30	—	43.7	3.5	
						T\$ 334	
						P\$ 453	
						TXT\$ 404	
						TXP\$ 489	
	86-FLEXRMCT24	86-FLEXRMCTH24	84 - 73	24	—	61.1	4.9
							T\$ 571
							P\$ 774
							TXT\$ 691
							TXP\$ 836
		72 - 61	24	—	52.4	4.2	
							T\$ 458
							P\$ 621
							TXT\$ 554
							TXP\$ 671
		60 - 49	24	—	43.7	3.5	
							T\$ 471
							P\$ 565
							TXT\$ 505
							TXP\$ 610
		48 - 36	24	—	34.9	2.8	
							T\$ 307
							P\$ 416
							TXT\$ 371
							TXP\$ 449

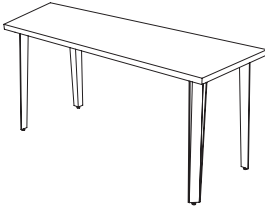

User Side



Envy Post Leg

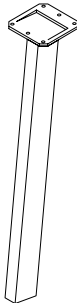

Vantage Post Leg

Description

- Must Specify Width In One Inch Increments from 36" to 84"
- Legs Required – Assembly Required
- Tops 60" and Larger Include Stiffener Bar
- Pre-Drilled for Ganging Brackets

What You Need – Leg Assembly (Not Available to be Sold Separately)

Envy Post Leg

	Weight	Cubes	List Price
08-0227APL4	20	1.6	\$ 513
Set of 4			

Vantage Post Leg

	Weight	Cubes	List Price
08-0227SPL4	20	1.6	\$ 415
Set of 4			

Description

- Adjustable Glides

Options: Specify & Add
Ganging

08-1505GB	Ganging Bracket Kit – Set of 2 with Thumb Screws	\$ 48
-----------	--	-------

Modesty Panel - Order Modesty to Match Top Size. Unit Will Fit Approach Side

Fixed – Use with 30" Trapezoids

	For	List Price
TFL: 86-FLEXMDTRP30	84 - 73 T\$ 339 TXT\$ 410	
HPL: 86-FLEXMDTRP30H	P\$ 459 TXP\$ 496	
	72 - 61 T\$ 306 TXT\$ 370	
	P\$ 415 TXP\$ 448	
	60 - 49 T\$ 288 TXT\$ 348	
	P\$ 390 TXP\$ 421	
	48 - 36 T\$ 271 TXT\$ 328	
	P\$ 367 TXP\$ 396	

Fixed – Use with 24" Trapezoids

	For	List Price
TFL: 86-FLEXMDTRP24	84 - 73 T\$ 332 TXT\$ 402	
HPL: 86-FLEXMDTRP24H	P\$ 450 TXP\$ 486	
	72 - 61 T\$ 299 TXT\$ 362	
	P\$ 405 TXP\$ 437	
	60 - 49 T\$ 282 TXT\$ 341	
	P\$ 382 TXP\$ 413	
	48 - 36 T\$ 264 TXT\$ 319	
	P\$ 358 TXP\$ 387	

Power & Data

See Pages 92 – 97 for Power and Data Options

Tri-One™ Series – Laminate
 Multi-Use Tables – Square Edge

Item	Model No.		W	D	H	Ship Wt	Cubic Ft	List Price
PENTAGON MODULAR CONFERENCE TOP SQUARE EDGE	TFL	HPL						
	86-30MCTP	86-30MCTPH	58 - 48%	18 - 25	—	44	3.6	T\$ 390 P\$ 528 TXT\$ 472 TXP\$ 570
	For Use with 30" Modular Tops							
	86-24MCTP	86-24MCTPH	46 1/3 - 37	18 - 23 1/2	—	33.7	2.8	T\$ 344 P\$ 466 TXT\$ 416 TXP\$ 503
	For Use with 24" Modular Tops							

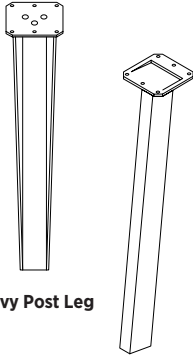
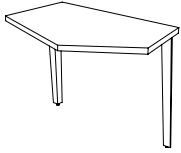

Envy Post Leg

Vantage Post Leg

Description

- Not a Freestanding Table
- Pre-Drilled for Ganging Brackets
- Legs Required – Assembly Required
- Ganging Brackets Required

What You Need – Leg Assembly *(Not Available to be Sold Separately)*
Envy Post Leg

	Weight	Cubes	List Price
08-0227APL2	10	0.8	\$ 294
Set of 2			

Vantage Post Leg

	Weight	Cubes	List Price
08-0227SPL2	10	0.8	\$ 245
Set of 2			

Description



- Adjustable Glides

Options: Specify & Add
Ganging – Requires 2 Sets

08-1505GB	Ganging Bracket Kit – Set of 2 with Thumb Screws	\$ 48
-----------	--	-------

Tri-One™ Series – Laminate

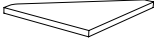
Multi-Use Tables – Square Edge

Item	Model No.	W	D	H	Ship Wt	Cubic Ft	List Price	
BRIDGE MODULAR CONFERENCE TOP SQUARE EDGE 	TFL	HPL						
	86-3090MCTB	86-3090MCTBH	42 3/4	30	—	18.2	2	T\$ 435 P\$ 589 TXT\$ 526 TXP\$ 636
	For Use with 30" Modular Tops							
	86-2490MCTB	86-2490MCTBH	34	24	—	11.6	1.3	T\$ 307 P\$ 416 TXT\$ 371 TXP\$ 449
	For Use with 24" Modular Tops							
	Description							
	<ul style="list-style-type: none"> • 90° Bridge Conference Top with Square Edge • Connects Two Conference Tops • Pre-Drilled for Ganging Brackets • Not a Freestanding Unit • Ganging Brackets Required 							
	Options: Specify & Add							
	Ganging – Requires 2 Sets							
	08-1505GB	Ganging Bracket Kit – Set of 2 with Thumb Screws						\$ 48
BRIDGE MODULAR CONFERENCE TOP SQUARE EDGE 	TFL	HPL						
	86-3045MCTB	86-3045MCTBH	27 1/2	30	—	16.1	2	T\$ 316 P\$ 428 TXT\$ 382 TXP\$ 462
	For Use with 30" Modular Tops							
	86-2445MCTB	86-2445MCTBH	22 3/4	24	—	10.8	1.4	T\$ 282 P\$ 382 TXT\$ 341 TXP\$ 413
	For Use with 24" Modular Tops							
	Description							
	<ul style="list-style-type: none"> • 45° Bridge Conference Top with Square Edge • Connects Two Conference Tops • Pre-Drilled for Ganging Brackets • Not a Freestanding Unit • Ganging Brackets Required 							
	Options: Specify & Add							
	Ganging – Requires 2 Sets							
	08-1505GB	Ganging Bracket Kit – Set of 2 with Thumb Screws						\$ 48
BRIDGE MODULAR CONFERENCE TOP SQUARE EDGE 	TFL	HPL						
	86-3030MCTB	86-3030MCTBH	19 3/4	30	—	11.4	1.5	T\$ 296 P\$ 401 TXT\$ 358 TXP\$ 433
	For Use with 30" Modular Tops							
	86-2430MCTB	86-2430MCTBH	16 3/4	24	—	8.6	1.1	T\$ 268 P\$ 363 TXT\$ 324 TXP\$ 392
	For Use with 24" Modular Tops							
	Description							
	<ul style="list-style-type: none"> • 30° Bridge Conference Top with Square Edge • Connects Two Conference Tops • Pre-Drilled for Ganging Brackets • Not a Freestanding Unit • Ganging Brackets Required 							
	Options: Specify & Add							
	Ganging – Requires 2 Sets							
	08-1505GB	Ganging Bracket Kit – Set of 2 with Thumb Screws						\$ 48

 Tri-One™ Series – Laminate
 Square Edge

Tri-One™ Series – Laminate
 Multi-Use Tables – Square Edge

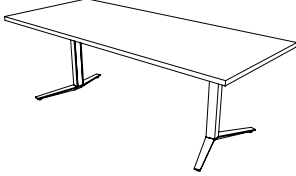
Item	Model No.	W	D	H	Ship Wt	Cubic Ft	List Price	
RECTANGULAR MEETING TABLES SQUARE EDGE 	TFL	HPL						
	86-4296MT	86-4296MTH	96	42	—	122.2	9.4	T\$ 736 P\$ 997 TXT\$ 891 TXP\$ 1077
	55" Kneespace							
	86-4284MT	86-4284MTH	84	42	—	106.9	8.2	T\$ 691 P\$ 936 TXT\$ 836 TXP\$ 1011
	47" Kneespace							
	86-4272MT	86-4272MTH	72	42	—	91.7	7.1	T\$ 614 P\$ 832 TXT\$ 743 TXP\$ 899
	39" Kneespace							
	86-4260MT	86-4260MTH	60	42	—	76.4	5.7	T\$ 563 P\$ 763 TXT\$ 681 TXP\$ 824
	31½" Kneespace							
	86-3696MT	86-3696MTH	96	36	—	104.8	8.1	T\$ 664 P\$ 900 TXT\$ 803 TXP\$ 972
	55" Kneespace							
	86-3684MT	86-3684MTH	84	36	—	92	7.1	T\$ 618 P\$ 837 TXT\$ 748 TXP\$ 904
	47" Kneespace							
	86-3672MT	86-3672MTH	72	36	—	78.6	6.1	T\$ 562 P\$ 762 TXT\$ 680 TXP\$ 823
	39" Kneespace							
	86-3660MT	86-3660MTH	60	36	—	65.5	5.1	T\$ 517 P\$ 701 TXT\$ 626 TXP\$ 757
	31½" Kneespace							

Description

- Seated Height Bases Required – Assembly Required

What You Need – Base (Not Available to be Sold Separately)
X-Base (2 Bases Required)

	Weight	Cubes	List Price
08-2630LXB	27	14.5	\$ 724

Y-Base

	Weight	Cubes	List Price
08-2828YLG96 For 96" Tables	47	6.5	\$ 1030
08-2828YLG84 For 84" Tables	43	5.4	\$ 1016
08-2828YLG72 For 72" Tables	39	4.3	\$ 994
08-2828YLG60 For 60" Tables	35	3.2	\$ 955

Power & Data

See Pages 92 – 97 for Power and Data Options

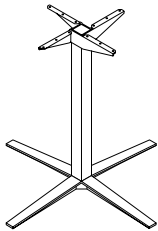
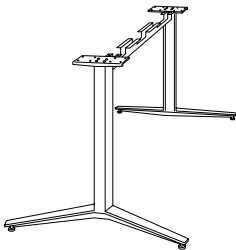
X-Base Detail

Y-Base Detail

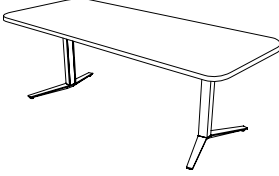
Tri-One™ Series – Laminate
 Multi-Use Tables – Square Edge

Item	Model No.	W	D	H	Ship Wt	Cubic Ft	List Price	
SOFT RECTANGULAR MEETING TABLES SQUARE EDGE 	TFL	HPL						
	86-4296SMT	86-4296SMTH	96	42	—	122.2	9.4	T\$ 711 P\$ 963 TXT\$ 860 TXP\$ 1040
	55" Kneespace							
	86-4284SMT	86-4284SMTH	84	42	—	106.9	8.2	T\$ 669 P\$ 906 TXT\$ 809 TXP\$ 978
	47" Kneespace							
	86-4272SMT	86-4272SMTH	72	42	—	91.7	7.1	T\$ 594 P\$ 805 TXT\$ 719 TXP\$ 869
	39" Kneespace							
	86-4260SMT	86-4260SMTH	60	42	—	76.4	5.7	T\$ 546 P\$ 740 TXT\$ 661 TXP\$ 799
	31½" Kneespace							
	86-3696SMT	86-3696SMTH	96	36	—	104.8	8.1	T\$ 640 P\$ 867 TXT\$ 774 TXP\$ 936
	55" Kneespace							
	86-3684SMT	86-3684SMTH	84	36	—	92	7.1	T\$ 597 P\$ 809 TXT\$ 722 TXP\$ 874
	47" Kneespace							
	86-3672SMT	86-3672SMTH	72	36	—	78.6	6.1	T\$ 544 P\$ 737 TXT\$ 658 TXP\$ 796
	39" Kneespace							
	86-3660SMT	86-3660SMTH	60	36	—	65.5	5.1	T\$ 501 P\$ 679 TXT\$ 606 TXP\$ 733
	31½" Kneespace							

Description

- Seated Height Bases Required – Assembly Required

What You Need – Base (Not Available to be Sold Separately)
X-Base (2 Bases Required)

	Weight	Cubes	List Price
08-2630LXB	27	14.5	\$ 724

Y-Base

	Weight	Cubes	List Price
08-2828YLG96 For 96" Tables	47	6.5	\$ 1030
08-2828YLG84 For 84" Tables	43	5.4	\$ 1016
08-2828YLG72 For 72" Tables	39	4.3	\$ 994
08-2828YLG60 For 60" Tables	35	3.2	\$ 955

Power & Data

See Pages 92 – 97 for Power and Data Options

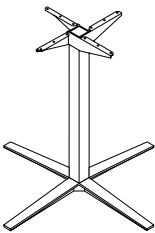

X-Base Detail

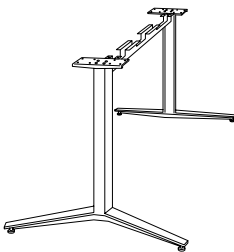

Y-Base Detail

Tri-One™ Series – Laminate
Multi-Use Tables – Square Edge

Item	Model No.	W	D	H	Ship Wt	Cubic Ft	List Price	
SQUARE MEETING TABLES SQUARE EDGE 	TFL	HPL						
	86-4242SQ	86-4242SQH	42	42	—	70	3.3	T\$ 432 P\$ 585 TXT\$ 523 TXP\$ 632
	86-3636SQ	86-3636SQH	36	36	—	37	2.5	T\$ 369 P\$ 500 TXT\$ 446 TXP\$ 540
	86-3030SQ	86-3030SQH	30	30	—	30	2.2	T\$ 324 P\$ 439 TXT\$ 392 TXP\$ 474

Description

- Bases Required – Assembly Required

What You Need – Base (Not Available to be Sold Separately)
Large X-Base – For Use with 42"

	Weight	Cubes	List Price
08-2642LXB 42" High Tables	33	20	\$ 785
08-2636LXB 36" High Tables	30	17.2	\$ 756
08-2630LXB 30" High Tables	27	14.5	\$ 724

Small X-Base – For Use with 36" and 30"

	Weight	Cubes	List Price
08-2042SXB 42" High Tables	27	15.9	\$ 732
08-2036SXB 36" High Tables	24	13.7	\$ 704
08-2030SXB 30" High Tables	21	11.6	\$ 675

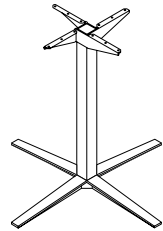
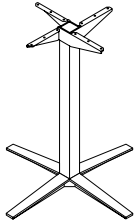
Large X-Base Detail

Small X-Base Detail

Tri-One™ Series – Laminate
 Multi-Use Tables – Square Edge

Item	Model No.	W	D	H	Ship Wt	Cubic Ft	List Price	
SOFT SQUARE MEETING TABLES SQUARE EDGE	TFL	HPL						
	86-4242SSQ	86-4242SSQH	42	42	—	70	3.3	T\$ 418 P\$ 566 TXT\$ 506 TXP\$ 611
	86-3636SSQ	86-3636SSQH	36	36	—	37	2.5	T\$ 358 P\$ 485 TXT\$ 433 TXP\$ 524
	86-3030SSQ	86-3030SSQH	30	30	—	30	2.2	T\$ 317 P\$ 430 TXT\$ 384 TXP\$ 464



Description

- Bases Required – Assembly Required

What You Need – Base (Not Available to be Sold Separately)

Large X-Base – For Use with 42"

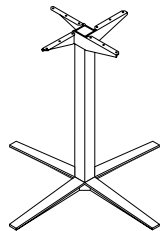
	Weight	Cubes	List Price
08-2642LXB 42" High Tables	33	20	\$ 785
08-2636LXB 36" High Tables	30	17.2	\$ 756
08-2630LXB 30" High Tables	27	14.5	\$ 724

Large X-Base Detail
Small X-Base – For Use with 36" and 30"

	Weight	Cubes	List Price
08-2042SXB 42" High Tables	27	15.9	\$ 732
08-2036SXB 36" High Tables	24	13.7	\$ 704
08-2030SXB 30" High Tables	21	11.6	\$ 675

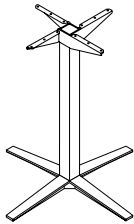
Small X-Base Detail

Tri-One™ Series – Laminate
 Multi-Use Tables – Square Edge

Item	Model No.	W	D	H	Ship Wt	Cubic Ft	List Price	
ROUND MEETING TABLES SQUARE EDGE	TFL	HPL						
	86-4848CT	86-4848CTH	48	48	—	95	4.3	T\$ 467 P\$ 633 TXT\$ 565 TXP\$ 684
	86-4242CT	86-4242CTH	42	42	—	70	3.3	T\$ 406 P\$ 550 TXT\$ 491 TXP\$ 594
	86-3636CT	86-3636CTH	36	36	—	37	2.5	T\$ 355 P\$ 481 TXT\$ 430 TXP\$ 519
	86-3030CT	86-3030CTH	30	30	—	30	2.2	T\$ 314 P\$ 425 TXT\$ 380 TXP\$ 459



Description

- Bases Required – Assembly Required

What You Need – Base (Not Available to be Sold Separately)

Large X-Base – For Use with 48" and 42"

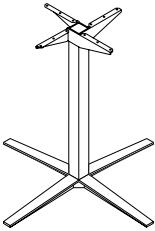
	Weight	Cubes	List Price
08-2642LXB 42" High Tables	33	20	\$ 785
08-2636LXB 36" High Tables	30	17.2	\$ 756
08-2630LXB 30" High Tables	27	14.5	\$ 724

Large X-Base Detail
Small X-Base – For Use with 36" and 30"

	Weight	Cubes	List Price
08-2042SXB 42" High Tables	27	15.9	\$ 732
08-2036SXB 36" High Tables	24	13.7	\$ 704
08-2030SXB 30" High Tables	21	11.6	\$ 675

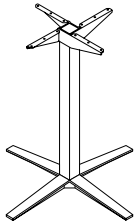
Small X-Base Detail

Tri-One™ Series – Laminate
 Multi-Use Tables – Square Edge

Item	Model No.		W	D	H	Ship Wt	Cubic Ft	List Price	
SOFT VIEW MEETING TABLES SQUARE EDGE	TFL	HPL							
	86-4296SVT	86-4296SVTH	96	42 - 36	—	122.2	9.4	T\$ 707 P\$ 958 TXT\$ 855 TXP\$ 1035	
	86-4284SVT	86-4284SVTH	84	42 - 36	—	106.9	8.2	T\$ 639 P\$ 866 TXT\$ 773 TXP\$ 935	
	86-4272SVT	86-4272SVTH	72	42 - 36	—	91.7	7.1	T\$ 593 P\$ 804 TXT\$ 718 TXP\$ 868	

Description

- Seated Height Bases Required – Assembly Required

What You Need – Base (Not Available to be Sold Separately)
X-Base (2 Bases Required)

	Weight	Cubes	List Price
08-2630LXB	27	14.5	\$ 724

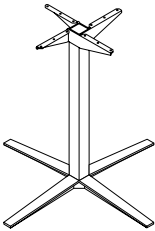

X-Base Detail

Y-Base

	Weight	Cubes	List Price
08-2828YLG96 For 96" Tables	47	6.5	\$ 1030
08-2828YLG84 For 84" Tables	43	5.4	\$ 1016
08-2828YLG72 For 72" Tables	39	4.3	\$ 994
08-2828YLG60 For 60" Tables	35	3.2	\$ 955

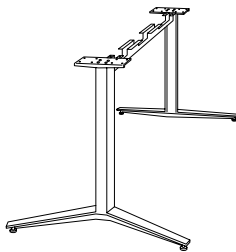

Y-Base Detail

Power & Data

See Pages 92 – 97 for Power and Data Options

Tri-One™ Series – Laminate
 Multi-Use Tables – Square Edge

Item	Model No.		W	D	H	Ship Wt	Cubic Ft	List Price	
ELLIPSE MEETING TABLES SQUARE EDGE	TFL	HPL							
	86-4284EMT	86-4284EMTH	84	48	—	106.9	8.2	T\$ 663 P\$ 898 TXT\$ 802 TXP\$ 970	
	86-3672EMT	86-3672EMTH	72	30	—	78.6	6.1	T\$ 539 P\$ 730 TXT\$ 652 TXP\$ 788	

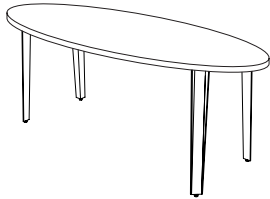
Description

- Includes Stiffener Bar
- Base Required – Assembly Required

What You Need – Leg Assembly *(Not Available to be Sold Separately)*
Envy Post Leg

	Weight	Cubes	List Price
08-0227APL4	20	1.6	\$ 513
Set of 4			

Vantage Post Leg

	Weight	Cubes	List Price
08-0227SPL4	20	1.6	\$ 415
Set of 4			

Description

- Choose from Envy Post Leg or Vantage Post Leg
- Adjustable Glides
- Assembly Required

Power & Data

See Pages 92 – 97 for Power and Data Options



Envy Post Leg

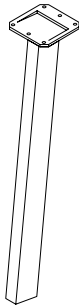

Vantage Post Leg

Tri-One™ Series – Laminate
Multi-Use Tables – Square Edge

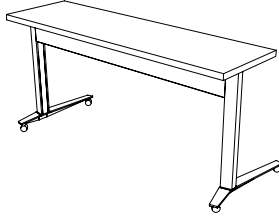
Item	Model No.	W	D	H	Ship Wt	Cubic Ft	List Price	
 TRAINING TABLES – 18" DEEP SQUARE EDGE	TFL	HPL						
	86-1872TT	86-1872TTH	72	18	–	49.3	3.2	T\$ 382 P\$ 518 TXT\$ 462 TXP\$ 559
	65½ Kneespace							
	86-1860TT	86-1860TTH	60	18	–	42.7	2.7	T\$ 345 P\$ 467 TXT\$ 417 TXP\$ 504
	53½ Kneespace							
	86-1848TT	86-1848TTH	48	18	–	36.2	2.2	T\$ 320 P\$ 434 TXT\$ 387 TXP\$ 469
	41½ Kneespace							

Description

- Rectangular Training Top with Square Edge
- Flip Mechanism for Nesting is Optional; See Options Below
- Pre-Drilled for Ganging Brackets
- Legs Required - Assembly Required

What You Need – Leg Assembly *(Not Available to be Sold Separately)*

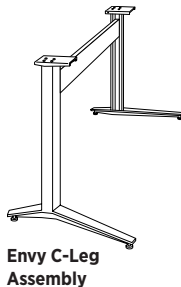
Envy C-Leg Assembly – For 18" Tables

Casters – Must Specify Soft Wheel or Hard Wheel

	Weight	Cubes	List Price
08-1828CLC72 For 72" Tables	36	4.3	\$ 840
08-1828CLC60 For 60" Tables	32	3.2	\$ 808
08-1828CLC48 For 48" Tables	28	2.9	\$ 777

Glides

08-1828CLG72 For 72" Tables	35	4.3	\$ 762
08-1828CLG60 For 60" Tables	31	3.2	\$ 729
08-1828CLG48 For 48" Tables	27	2.9	\$ 699

Description

- Includes Trough/Modesty
- Legs Feature Removable Panel for Wire Management

Options: Specify & Add
Ganging

08-1505GB	Ganging Bracket Kit – Set of 2 with Thumb Screws	\$ 48
-----------	--	-------

Nesting

08-FLIP	Flip Mechanism for Nesting - Factory Installed	\$ 299
---------	--	--------

Power & Data

See Pages 92 – 97 for Power and Data Options

Tri-One™ Series – Laminate

Multi-Use Tables – Square Edge

Item	Model No.	W	D	H	Ship Wt	Cubic Ft	List Price	
RECTANGULAR TRAINING TABLES – 24" DEEP SQUARE EDGE	TFL	HPL						
	86-2472TT	86-2472TTH	72	24	–	62.4	4.2	T\$ 424 P\$ 575 TXT\$ 513 TXP\$ 621
	65½ Kneespace							
	86-2460TT	86-2460TTH	60	24	–	53.7	3.5	T\$ 380 P\$ 515 TXT\$ 460 TXP\$ 556
	53¾ Kneespace							
	86-2448TT	86-2448TTH	48	24	–	44.9	2.8	T\$ 349 P\$ 473 TXT\$ 422 TXP\$ 511
	41½ Kneespace							

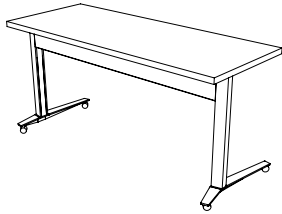
Description

- Flip Mechanism for Nesting is Optional; See Options Below
- Pre-Drilled for Ganging Brackets
- Base Required – Assembly Required

What You Need – Leg Assembly (Not Available to be Sold Separately)

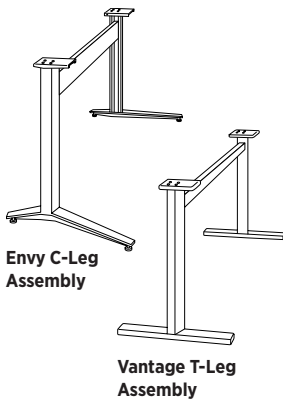
Envy C-Leg Assembly – For 24" - 30" Tables

Casters – Must Specify Soft Wheel or Hard Wheel

	Weight	Cubes	List Price
08-2428CLC72 For 72" Tables	40	4.3	\$ 914
08-2428CLC60 For 60" Tables	36	3.2	\$ 879
08-2428CLC48 For 48" Tables	32	2.9	\$ 851

Glides

08-2428CLG72 For 72" Tables	39	4.3	\$ 833
08-2428CLG60 For 60" Tables	35	3.2	\$ 801
08-2428CLG48 For 48" Tables	31	2.9	\$ 772

Description

- Includes Trough/Modesty and Features Removable Panels for Wire Management

Options: Specify & Add
Ganging

08-1505GB	Ganging Bracket Kit – Set of 2 with Thumb Screws	\$ 48
-----------	--	-------

Nesting

08-FLIP	Flip Mechanism for Nesting – Factory Installed	\$ 299
---------	--	--------

Modesty Panel – For Use with Vantage T-Legs

Fixed – To Be Used with Standard Fixed Table Legs

	For	List Price
TFL: 86-0872MD	72	T\$ 312 TXT\$ 378
HPL: 86-0872MDH		P\$ 423 TXP\$ 457
TFL: 86-0860MD	60	T\$ 294 TXT\$ 356
HPL: 86-0860MDH		P\$ 398 TXP\$ 430
TFL: 86-0848MD	48	T\$ 285 TXT\$ 345
HPL: 86-0848MDH		P\$ 386 TXP\$ 417

Vantage T-Leg Assembly – For 24" - 30" Tables

Casters – Must Specify Soft Wheel or Hard Wheel

	Weight	Cubes	List Price
08-2428TLC72 For 72" Tables	36	4.3	\$ 437
08-2428TLC60 For 60" Tables	32	3.2	\$ 418
08-2428TLC48 For 48" Tables	28	2.9	\$ 402

Glides

08-2428TLG72 For 72" Tables	35	4.3	\$ 421
08-2428TLG60 For 60" Tables	31	3.2	\$ 402
08-2428TLG48 For 48" Tables	27	2.9	\$ 386

Description

- Includes Stretcher Rail
- Optional Modesty Sold Below

Hinged – To Be Used with Flip Mechanism for Nesting

	For	List Price
TFL: 86-0865HMD	72	T\$ 312 TXT\$ 378
HPL: 86-0865HMDH		P\$ 423 TXP\$ 457
TFL: 86-0853HMD	60	T\$ 295 TXT\$ 357
HPL: 86-0853HMDH		P\$ 400 TXP\$ 432
TFL: 86-0841HMD	48	T\$ 286 TXT\$ 346
HPL: 86-0841HMDH		P\$ 388 TXP\$ 419

Power & Data

See Pages 92 – 97 for Power and Data Options

Tri-One™ Series – Laminate

Multi-Use Tables – Square Edge

Item	Model No.	W	D	H	Ship Wt	Cubic Ft	List Price	
RECTANGULAR TRAINING TABLES – 30" DEEP SQUARE EDGE	TFL	HPL						
	86-3072TT	86-3072TTH	72	30	–	75.5	5.2	T\$ 464 P\$ 629 TXT\$ 561 TXP\$ 679
	65½ Kneespace							
	86-3060TT	86-3060TTH	60	30	–	64.6	4.3	T\$ 414 P\$ 561 TXT\$ 501 TXP\$ 606
	53¾ Kneespace							
	86-3048TT	86-3048TTH	48	30	–	53.7	3.5	T\$ 377 P\$ 511 TXT\$ 456 TXP\$ 552
	41½ Kneespace							

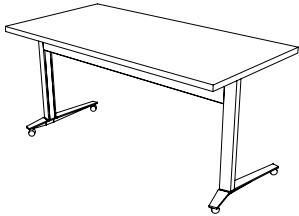
Description

- Flip Mechanism for Nesting is Optional; See Options Below
- Pre-Drilled for Ganging Brackets
- Base Required – Assembly Required

What You Need – Leg Assembly *(Not Available to be Sold Separately)*
Envy C-Leg Assembly – For 24" - 30" Tables
Casters – Must Specify Soft Wheel or Hard Wheel

	Weight	Cubes	List Price
08-2428CLC72 For 72" Tables	40	4.3	\$ 914
08-2428CLC60 For 60" Tables	36	3.2	\$ 879
08-2428CLC48 For 48" Tables	32	2.9	\$ 851

Glides

08-2428CLG72 For 72" Tables	39	4.3	\$ 833
08-2428CLG60 For 60" Tables	35	3.2	\$ 801
08-2428CLG48 For 48" Tables	31	2.9	\$ 772

Description

- Includes Trough/Modesty and Features Removable Panels for Wire Management

Options: Specify & Add
Ganging

08-1505GB	Ganging Bracket Kit – Set of 2 with Thumb Screws	\$ 48
-----------	--	-------

Nesting

08-FLIP	Flip Mechanism for Nesting – Factory Installed	\$ 299
---------	--	--------

Modesty Panel – For Use with Vantage T-Legs
Fixed – To Be Used with Standard Fixed Table Legs

	For	List Price
TFL: 86-0872MD	72	T\$ 312 TXT\$ 378
HPL: 86-0872MDH		P\$ 423 TXP\$ 457
TFL: 86-0860MD	60	T\$ 294 TXT\$ 356
HPL: 86-0860MDH		P\$ 398 TXP\$ 430
TFL: 86-0848MD	48	T\$ 285 TXT\$ 345
HPL: 86-0848MDH		P\$ 386 TXP\$ 417

Power & Data

See Pages 92 – 97 for Power and Data Options

Vantage T-Leg Assembly – For 24" - 30" Tables
Casters – Must Specify Soft Wheel or Hard Wheel

	Weight	Cubes	List Price
08-2428TLC72 For 72" Tables	36	4.3	\$ 437
08-2428TLC60 For 60" Tables	32	3.2	\$ 418
08-2428TLC48 For 48" Tables	28	2.9	\$ 402

Glides

08-2428TLG72 For 72" Tables	35	4.3	\$ 421
08-2428TLG60 For 60" Tables	31	3.2	\$ 402
08-2428TLG48 For 48" Tables	27	2.9	\$ 386

Description

- Includes Stretcher Rail
- Optional Modesty Sold Below

Tri-One™ Laminate

Multi-Use Table Collection

Knife Edge

How to Order

	QTY	MODEL NO.	DESCRIPTION	
TOP	10	86-1872TTKH 08-FLIP	Laminate Color Flip Mechanism	TK
BASE	10	08-1828CLC72	Optional Caster	Soft Caster
DATA	10	01-PDUUNDERW		
	2	01-PPOWER		
	5	01-2JUMP		



Specifications

TOPS

Tops are 1-3/16" high-pressure laminate (HPL) fused to particle-board core. Select from solid color, patterned, and wood-grained laminates, including textured laminates. Knife Edge (K) profile is available on HPL tops featuring a 3mm PVC rim on all standard laminates. Training and Modular Conference tops feature shaped profiles on the user side while meeting tables are shaped on four sides. Tops are pre-drilled for the specified base assembly and for ganging where applicable.

LEG ASSEMBLY

All leg styles are powder-coated aluminum and include a 5mm steel mounting plate. Envy style legs are aluminum extrusion while Vantage style legs are steel welded. Envy C-Legs and Envy Y-Legs include troughs which act as modesty panels and route cables cleanly to the legs where a removable panel provides access. Vantage T-Legs are equipped with a stretcher rail for secure support. All legs include adjustable glides or casters.

FLIP MECHANISM

Indiana Furniture's training tables offer an exclusive flip mechanism design which can be accessed from any position. Optional flip mechanisms are factory installed and must be specified at the time of order.

GANGING

All training tables and modular conference tables are pre-drilled with threaded inserts for ganging applications. Ganging brackets include quick release thumb screws for ease of use. No tools required.

POWER PORTS

Power ports are available for under-surface mount or routed into work surfaces. Units comply with FCC Part 15A and UL. Both standard plugs and daisy-chain connections are offered. Daisy chain applications are non-sequential and connect up to 8 modules.



Laminate Options – Tops and Modesty Panels

STANDARD HPL (P) OPTIONS – MUST SPECIFY

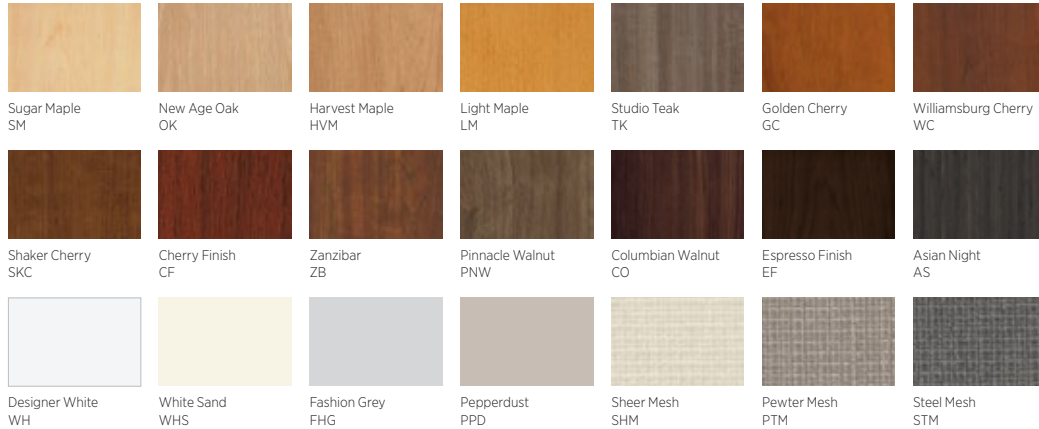

TEXTURED HPL (TXP) OPTIONS – MUST SPECIFY

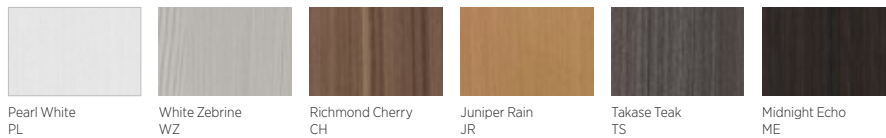

Laminate Options – Modesty Panels

STANDARD TFL (T) OPTIONS – MUST SPECIFY

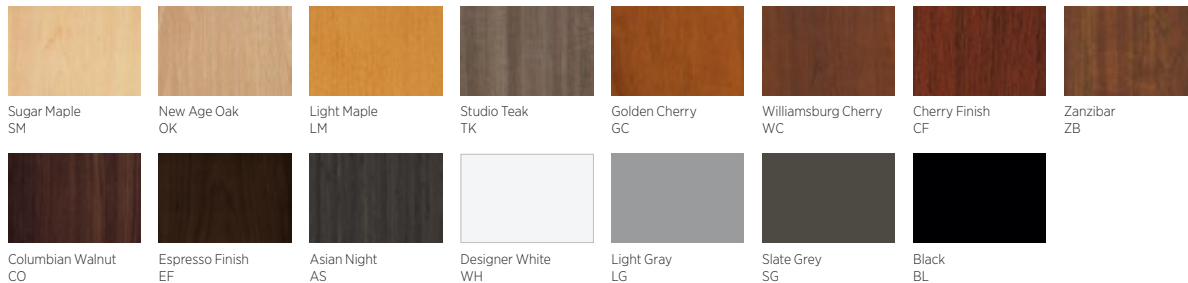

TEXTURED HPL (TXP) OPTIONS – MUST SPECIFY

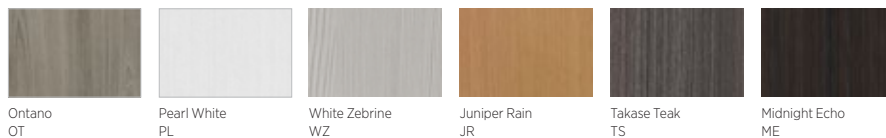

Edge Options



Knife
K

WIRE MANAGEMENT GROMMET

Optional black grommets are available in Training Tables and Modular Conference Tops. Please specify any combination of Left, Right, and Center and add \$47 list for each grommet.

Specify & Add: GL – Grommet Left
 GR – Grommet Right
 GC – Grommet Center

Grommets may be ordered in non-standard locations. Please call Customer Service to assist with how to order and additional lead time requirements.

18" Training Tables



GL/GR – 10" from end, 12" from user side
 GC – Grommet Center – 12" from user side

24" Training Tables

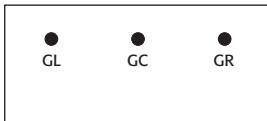

GL/GR – 10" from end, 16.5" from user side
 GC – Grommet Center – 16.5" from user side

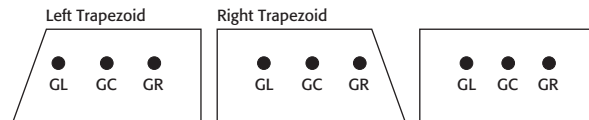
30" Training Tables

GL/GR – 10" from end, 20" from user side
 GC – Grommet Center – 20" from user side

24" Modular Conference Tables

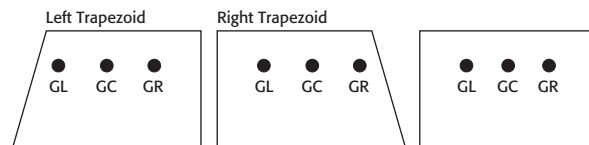
GL/GR – 10" from end based on widest dimension, 13 3/8" from user side
 GC – Grommet Center – 13 3/8" from user side

30" Modular Conference Tables

GL/GR – 10" from end based on widest dimension, 19 3/8" from user side
 GC – Grommet Center – 19 3/8" from user side

POWER ACCESSORIES

Indiana Furniture offers Power Accessories for training tables, modular conference tops, and rectangular, ellipse or view meeting tables that can be mounted below the worksurface or in the worksurface top. Power Accessories that include a bezel frame will be routed for field placement at no additional charge. See pages 92-97 to specify and order Power Accessories.

Power Accessories will be routed on center, left to right:

- 18" Training Tables – 12" from user side
- 24" Training Tables – 16.5" from user side
- 30" Training Tables – 20" from user side
- 24" Modular Conference Tables – 13 3/8" from user side
- 30" Modular Conference Tables – 19 3/8" from user side
- Meeting Tables – On center, front to back

Tri-One™ Series – Laminate
 Multi-Use Tables – Knife Edge

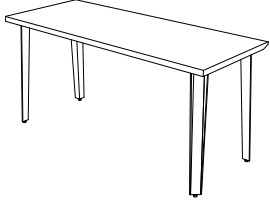
Item	Model No.	W	D	H	Ship Wt	Cubic Ft	List Price
RECTANGULAR MODULAR CONFERENCE TOP KNIFE EDGE 	HPL 86-3084MCTKH	84	30	—	76.4	6	P\$ 1134 TXP\$ 1225
	86-3072MCTKH	72	30	—	65.5	5.1	P\$ 920 TXP\$ 994
	86-3060MCTKH	60	30	—	54.6	4.3	P\$ 825 TXP\$ 891
	86-3048MCTKH	48	30	—	43.7	3.5	P\$ 618 TXP\$ 667
	86-2484MCTKH	84	24	—	61.1	4.9	P\$ 1055 TXP\$ 1139
	86-2472MCTKH	72	24	—	52.4	4.2	P\$ 849 TXP\$ 917
	86-2460MCTKH	60	24	—	43.7	3.5	P\$ 770 TXP\$ 832
	86-2448MCTKH	48	24	—	34.9	2.8	P\$ 571 TXP\$ 617

Description

- Flexible Sizes Available, See Page 69
- Legs Required – Assembly Required
- Pre-Drilled for Ganging Brackets
- Tops 60" and Larger Include Stiffener Bar

What You Need – Leg Assembly *(Not Available to be Sold Separately)*
Envy Post Leg

	Weight	Cubes	List Price
08-0227APL4	20	1.6	\$ 513
Set of 4			

Vantage Post Leg

	Weight	Cubes	List Price
08-0227SPL4	20	1.6	\$ 415
Set of 4			



Envy Post Leg

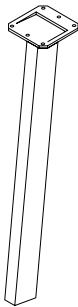

Vantage Post Leg

Description

- Adjustable Glides

Options: Specify & Add
Ganging

08-1505GB	Ganging Bracket Kit – Set of 2 with Thumb Screws	\$ 48
-----------	--	-------

Modesty Panel
Fixed

	For	List Price
TFL: 86-0884MD	84	T\$ 321 TXT\$ 388
HPL: 86-0884MDH		P\$ 435 TXP\$ 470
TFL: 86-0872MD	72	T\$ 312 TXT\$ 378
HPL: 86-0872MDH		P\$ 423 TXP\$ 457
TFL: 86-0860MD	60	T\$ 294 TXT\$ 356
HPL: 86-0860MDH		P\$ 398 TXP\$ 430
TFL: 86-0848MD	48	T\$ 285 TXT\$ 345
HPL: 86-0848MDH		P\$ 386 TXP\$ 417

Power & Data

See Pages 92 – 97 for Power and Data Options

Tri-One™ Series – Laminate
 Multi-Use Tables – Knife Edge

Item	Model No.	W	D	H	Ship Wt	Cubic Ft	List Price
RECTANGULAR MODULAR CONFERENCE TOP KNIFE EDGE - FLEXIBLE SIZES	HPL						
	86-FLEXMCTKH30	84 - 73	30	—	76.4	6	P\$ 1134 TXP\$ 1225
		72 - 61	30	—	65.5	5.1	P\$ 920 TXP\$ 994
		60 - 49	30	—	54.6	4.3	P\$ 825 TXP\$ 891
		48 - 36	30	—	43.7	3.5	P\$ 618 TXP\$ 667
	HPL						
	86-FLEXMCTKH24	84 - 73	24	—	61.1	4.9	P\$ 1055 TXP\$ 1139
		72 - 61	24	—	52.4	4.2	P\$ 849 TXP\$ 917
		60 - 49	24	—	43.7	3.5	P\$ 770 TXP\$ 832
		48 - 36	24	—	34.9	2.8	P\$ 571 TXP\$ 617

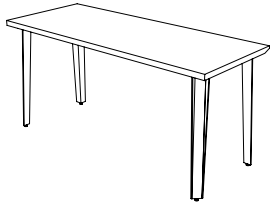
Description

- Must Specify Width In One Inch Increments from 36" to 84"
- Legs Required – Assembly Required
- Tops 60" and Larger Include Stiffener Bar
- Pre-Drilled for Ganging Brackets

What You Need – Leg Assembly *(Not Available to be Sold Separately)*
Envy Post Leg

	Weight	Cubes	List Price
08-0227APL4	20	1.6	\$ 513
Set of 4			

Vantage Post Leg

	Weight	Cubes	List Price
08-0227SPL4	20	1.6	\$ 415
Set of 4			



Envy Post Leg

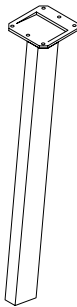

Vantage Post Leg

Description

- Adjustable Guides

Options: Specify & Add
Ganging

08-1505GB	Ganging Bracket Kit – Set of 2 with Thumb Screws	\$ 48
-----------	--	-------

Modesty Panel - Order Modesty to Match Top Size. Unit Will Fit Approach Side



Fixed

	For	List Price
TFL: 86-FLEXMD	84 - 73	T\$ 321 TXT\$ 388
HPL: 86-FLEXMDH		P\$ 435 TXP\$ 470
	72 - 61	T\$ 312 TXT\$ 378
		P\$ 423 TXP\$ 457
	60 - 49	T\$ 294 TXT\$ 356
		P\$ 398 TXP\$ 430
	48 - 36	T\$ 285 TXT\$ 345
		P\$ 386 TXP\$ 417

Power & Data

See Pages 92 – 97 for Power and Data Options

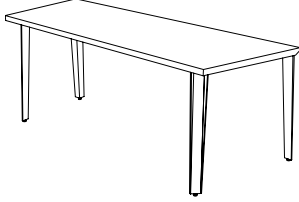
Tri-One™ Series – Laminate
 Multi-Use Tables – Knife Edge

Item	Model No.	W	D	H	Ship Wt	Cubic Ft	List Price
LEFT TRAPEZOID MODULAR CONFERENCE TOP KNIFE EDGE   User Side	HPL						
	86-3084LMCTKH	84	30	—	76.4	6	P\$ 1090 TXP\$ 1177
	86-3072LMCTKH	72	30	—	65.5	5.1	P\$ 880 TXP\$ 950
	86-3060LMCTKH	60	30	—	54.6	4.3	P\$ 794 TXP\$ 858
	86-3048LMCTKH	48	30	—	43.7	3.5	P\$ 593 TXP\$ 640
	86-2484LMCTKH	84	24	—	61.1	4.9	P\$ 1014 TXP\$ 1095
	86-2472LMCTKH	72	24	—	52.4	4.2	P\$ 814 TXP\$ 879
	86-2460LMCTKH	60	24	—	43.7	3.5	P\$ 740 TXP\$ 799
	86-2448LMCTKH	48	24	—	34.9	2.8	P\$ 545 TXP\$ 589

Description

- Flexible Sizes Available, See Page 71
- Legs Required – Assembly Required
- Pre-Drilled for Ganging Brackets
- Tops 60" and Larger Include Stiffener Bar

What You Need – Leg Assembly *(Not Available to be Sold Separately)*
Envy Post Leg

	Weight	Cubes	List Price
08-0227APL4	20	1.6	\$ 513
Set of 4			

Vantage Post Leg

	Weight	Cubes	List Price
08-0227SPL4	20	1.6	\$ 415
Set of 4			



Envy Post Leg

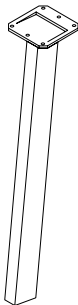

Vantage Post Leg

Description

- Adjustable Glides

Options: Specify & Add
Ganging

08-1505GB	Ganging Bracket Kit – Set of 2 with Thumb Screws	\$ 48
-----------	--	-------

Modesty Panel
Fixed – Use with 30" Trapezoids

	For	List Price
TFL: 86-0884MDT30	84	T\$ 339 TXT\$ 410
HPL: 86-0884MDTH30		P\$ 459 TXP\$ 496
TFL: 86-0872MDT30	72	T\$ 306 TXT\$ 370
HPL: 86-0872MDTH30		P\$ 415 TXP\$ 448
TFL: 86-0860MDT30	60	T\$ 288 TXT\$ 348
HPL: 86-0860MDTH30		P\$ 390 TXP\$ 421
TFL: 86-0848MDT30	48	T\$ 271 TXT\$ 328
HPL: 86-0848MDTH30		P\$ 367 TXP\$ 396



Fixed – Use with 24" Trapezoids

	For	List Price
TFL: 86-0884MDT24	84	T\$ 332 TXT\$ 402
HPL: 86-0884MDTH24		P\$ 450 TXP\$ 486
TFL: 86-0872MDT24	72	T\$ 299 TXT\$ 362
HPL: 86-0872MDTH24		P\$ 405 TXP\$ 437
TFL: 86-0860MDT24	60	T\$ 282 TXT\$ 341
HPL: 86-0860MDTH24		P\$ 382 TXP\$ 413
TFL: 86-0848MDT24	48	T\$ 264 TXT\$ 319
HPL: 86-0848MDTH24		P\$ 358 TXP\$ 387

Power & Data

See Pages 92 – 97 for Power and Data Options

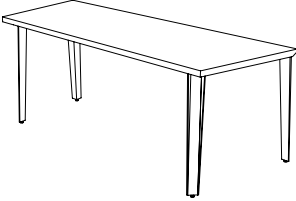
Tri-One™ Series – Laminate
 Multi-Use Tables – Knife Edge

Item	Model No.	W	D	H	Ship Wt	Cubic Ft	List Price
LEFT TRAPEZOID MODULAR CONFERENCE TOP KNIFE EDGE   User Side	HPL						
	86-FLEXLMCTKH30	84 - 73	30	—	76.4	6	P\$ 1090 TXP\$ 1177
		72 - 61	30	—	65.5	5.1	P\$ 880 TXP\$ 950
		60 - 49	30	—	54.6	4.3	P\$ 794 TXP\$ 858
		48 - 36	30	—	43.7	3.5	P\$ 593 TXP\$ 640
	86-FLEXLMCTKH24	84 - 73	24	—	61.1	4.9	P\$ 1014 TXP\$ 1095
		72 - 61	24	—	52.4	4.2	P\$ 814 TXP\$ 879
		60 - 49	24	—	43.7	3.5	P\$ 740 TXP\$ 799
		48 - 36	24	—	34.9	2.8	P\$ 545 TXP\$ 589

Description

- Must Specify Width In One Inch Increments from 36" to 84"
- Legs Required – Assembly Required
- Tops 60" and Larger Include Stiffener Bar
- Pre-Drilled for Ganging Brackets

What You Need – Leg Assembly *(Not Available to be Sold Separately)*
Envy Post Leg

	Weight	Cubes	List Price
08-0227APL4	20	1.6	\$ 513
Set of 4			

Vantage Post Leg

	Weight	Cubes	List Price
08-0227SPL4	20	1.6	\$ 415
Set of 4			

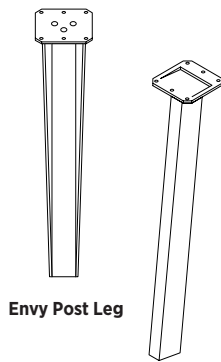

Envy Post Leg

Vantage Post Leg

Description

- Adjustable Glides

Options: Specify & Add
Ganging

08-1505GB	Ganging Bracket Kit – Set of 2 with Thumb Screws	\$ 48
-----------	--	-------

Modesty Panel - Order Modesty to Match Top Size. Unit Will Fit Approach Side

Fixed – Use with 30" Trapezoids

	For	List Price
TFL: 86-FLEXMDTRP30	84 - 73 T\$ 339 TXT\$ 410	
HPL: 86-FLEXMDTRP30H	P\$ 459 TXP\$ 496	
	72 - 61 T\$ 306 TXT\$ 370	
	P\$ 415 TXP\$ 448	
	60 - 49 T\$ 288 TXT\$ 348	
	P\$ 390 TXP\$ 421	
	48 - 36 T\$ 271 TXT\$ 328	
	P\$ 367 TXP\$ 396	



Fixed – Use with 24" Trapezoids

	For	List Price
TFL: 86-FLEXMDTRP24	84 - 73 T\$ 332 TXT\$ 402	
HPL: 86-FLEXMDTRP24H	P\$ 450 TXP\$ 486	
	72 - 61 T\$ 299 TXT\$ 362	
	P\$ 405 TXP\$ 437	
	60 - 49 T\$ 282 TXT\$ 341	
	P\$ 382 TXP\$ 413	
	48 - 36 T\$ 264 TXT\$ 319	
	P\$ 358 TXP\$ 387	

Power & Data

See Pages 92 – 97 for Power and Data Options

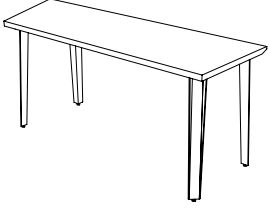
Tri-One™ Series – Laminate
 Multi-Use Tables – Knife Edge

Item	Model No.	W	D	H	Ship Wt	Cubic Ft	List Price
RIGHT TRAPEZOID MODULAR CONFERENCE TOP KNIFE EDGE   User Side	HPL						
	86-3084RMCTKH	84	30	—	76.4	6	P\$ 1090 TXP\$ 1177
	86-3072RMCTKH	72	30	—	65.5	5.1	P\$ 880 TXP\$ 950
	86-3060RMCTKH	60	30	—	54.6	4.3	P\$ 794 TXP\$ 858
	86-3048RMCTKH	48	30	—	43.7	3.5	P\$ 593 TXP\$ 640
	86-2484RMCTKH	84	24	—	61.1	4.9	P\$ 1014 TXP\$ 1095
	86-2472RMCTKH	72	24	—	52.4	4.2	P\$ 814 TXP\$ 879
	86-2460RMCTKH	60	24	—	43.7	3.5	P\$ 740 TXP\$ 799
	86-2448RMCTKH	48	24	—	34.9	2.8	P\$ 545 TXP\$ 589

Description

- Flexible Sizes Available, See Page 73
- Legs Required – Assembly Required
- Pre-Drilled for Ganging Brackets
- Tops 60" and Larger Include Stiffener Bar

What You Need – Leg Assembly *(Not Available to be Sold Separately)*
Envy Post Leg

	Weight	Cubes	List Price
08-0227APL4	20	1.6	\$ 513
Set of 4			

Vantage Post Leg

	Weight	Cubes	List Price
08-0227SPL4	20	1.6	\$ 415
Set of 4			

Description

- Adjustable Glides

Options: Specify & Add
Ganging

08-1505GB	Ganging Bracket Kit – Set of 2 with Thumb Screws	\$ 48
-----------	--	-------

Modesty Panel
Fixed – Use with 30" Trapezoids

	For	List Price
TFL: 86-0884MDT30	84	T\$ 339 TXT\$ 410
HPL: 86-0884MDTH30		P\$ 459 TXP\$ 496
TFL: 86-0872MDT30	72	T\$ 306 TXT\$ 370
HPL: 86-0872MDTH30		P\$ 415 TXP\$ 448
TFL: 86-0860MDT30	60	T\$ 288 TXT\$ 348
HPL: 86-0860MDTH30		P\$ 390 TXP\$ 421
TFL: 86-0848MDT30	48	T\$ 271 TXT\$ 328
HPL: 86-0848MDTH30		P\$ 367 TXP\$ 396

Fixed – Use with 24" Trapezoids

	For	List Price
TFL: 86-0884MDT24	84"	T\$ 332 TXT\$ 402
HPL: 86-0884MDTH24		P\$ 450 TXP\$ 486
TFL: 86-0872MDT24	72"	T\$ 299 TXT\$ 362
HPL: 86-0872MDTH24		P\$ 405 TXP\$ 437
TFL: 86-0860MDT24	60"	T\$ 282 TXT\$ 341
HPL: 86-0860MDTH24		P\$ 382 TXP\$ 413
TFL: 86-0848MDT24	48"	T\$ 264 TXT\$ 319
HPL: 86-0848MDTH24		P\$ 358 TXP\$ 387

Power & Data

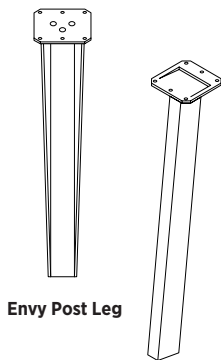

See Pages 92 – 97 for Power and Data Options



Envy Post Leg

Vantage Post Leg

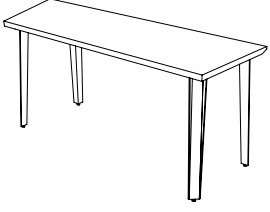
Tri-One™ Series – Laminate
 Multi-Use Tables – Knife Edge

Item	Model No.	W	D	H	Ship Wt	Cubic Ft	List Price
RIGHT TRAPEZOID MODULAR CONFERENCE TOP KNIFE EDGE   User Side	HPL						
	86-FLEXRMCTKH30	84 - 73	30	—	76.4	6	P\$ 1090 TXP\$ 1177
		72 - 61	30	—	65.5	5.1	P\$ 880 TXP\$ 950
		60 - 49	30	—	54.6	4.3	P\$ 794 TXP\$ 858
		48 - 36	30	—	43.7	3.5	P\$ 593 TXP\$ 640
	86-FLEXRMCTKH24	84 - 73	24	—	61.1	4.9	P\$ 1014 TXP\$ 1095
		72 - 61	24	—	52.4	4.2	P\$ 814 TXP\$ 879
		60 - 49	24	—	43.7	3.5	P\$ 740 TXP\$ 799
		48 - 36	24	—	34.9	2.8	P\$ 545 TXP\$ 589

Description

- Must Specify Width In One Inch Increments from 36" to 84"
- Legs Required – Assembly Required
- Tops 60" and Larger Include Stiffener Bar
- Pre-Drilled for Ganging Brackets

What You Need – Leg Assembly *(Not Available to be Sold Separately)*
Envy Post Leg

	Weight	Cubes	List Price
08-0227APL4	20	1.6	\$ 513
Set of 4			

Vantage Post Leg

	Weight	Cubes	List Price
08-0227SPL4	20	1.6	\$ 415
Set of 4			

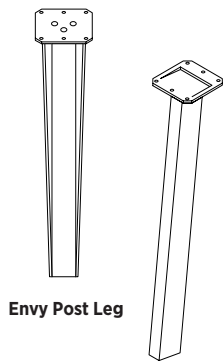

Envy Post Leg

Vantage Post Leg

Description

- Adjustable Glides

Options: Specify & Add
Ganging

08-1505GB	Ganging Bracket Kit – Set of 2 with Thumb Screws	\$ 48
-----------	--	-------

Modesty Panel - Order Modesty to Match Top Size. Unit Will Fit Approach Side

Fixed – Use with 30" Trapezoids

	For	List Price
TFL: 86-FLEXMDTRP30	84 - 73 T\$ 339 TXT\$ 410	
HPL: 86-FLEXMDTRP30H	P\$ 459 TXP\$ 496	
	72 - 61 T\$ 306 TXT\$ 370	
	P\$ 415 TXP\$ 448	
	60 - 49 T\$ 288 TXT\$ 348	
	P\$ 390 TXP\$ 421	
	48 - 36 T\$ 271 TXT\$ 328	
	P\$ 367 TXP\$ 396	

Fixed – Use with 24" Trapezoids

	For	List Price
TFL: 86-FLEXMDTRP24	84 - 73 T\$ 332 TXT\$ 402	
HPL: 86-FLEXMDTRP24H	P\$ 450 TXP\$ 486	
	72 - 61 T\$ 299 TXT\$ 362	
	P\$ 405 TXP\$ 437	
	60 - 49 T\$ 282 TXT\$ 341	
	P\$ 382 TXP\$ 413	
	48 - 36 T\$ 264 TXT\$ 319	
	P\$ 358 TXP\$ 387	

Power & Data

See Pages 92 – 97 for Power and Data Options

Tri-One™ Series – Laminate
 Multi-Use Tables – Knife Edge

Item	Model No.	W	D	H	Ship Wt	Cubic Ft	List Price
PENTAGON MODULAR CONFERENCE TOP KNIFE EDGE	HPL 86-30MCTPKH	58 - 48 $\frac{5}{8}$	18 - 25	—	44	3.6	P\$ 692 TXP\$ 747

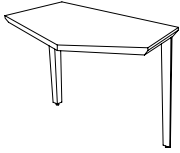

For Use with 30" Modular Tops

86-24MCTPKH	46 $\frac{1}{2}$ - 37	18 - 23 $\frac{1}{2}$	—	33.7	3.6	P\$ 610 TXP\$ 659
-------------	-----------------------	-----------------------	---	------	-----	----------------------

For Use with 24" Modular Tops

Description

- Not a Freestanding Table
- Pre-Drilled for Ganging Brackets
- Legs Required – Assembly Required
- Ganging Brackets Required

What You Need – Leg Assembly *(Not Available to be Sold Separately)*
Envy Post Leg

	Weight	Cubes	List Price
08-0227APL2	10	0.8	\$ 294
Set of 2			

Vantage Post Leg

	Weight	Cubes	List Price
08-0227SPL2	10	0.8	\$ 245
Set of 2			



Envy Post Leg

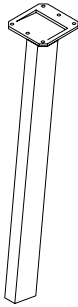

Vantage Post Leg



Description

- Adjustable Glides

Options: Specify & Add
Ganging – Requires 2 Sets

08-1505GB	Ganging Bracket Kit – Set of 2 with Thumb Screws	\$ 48
-----------	--	-------

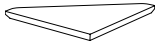
Tri-One™ Series – Laminate
 Multi-Use Tables – Knife Edge

Item	Model No.	W	D	H	Ship Wt	Cubic Ft	List Price
BRIDGE MODULAR CONFERENCE TOP KNIFE EDGE 	HPL						
	86-3090MCTBKH	42 3/4	30	—	18.2	2	P\$ 772 TXP\$ 834
	For Use with 30" Modular Tops						
	86-2490MCTBKH	34	24	—	11.6	1.3	P\$ 545 TXP\$ 589
	For Use with 24" Modular Tops						
	Description						
	<ul style="list-style-type: none"> • 90° Bridge Conference Top with Knife Edge • Connects Two Conference Tops • Pre-Drilled for Ganging Brackets • Not a Freestanding Unit • Ganging Brackets Required 						
	Options: Specify & Add						
	Ganging – Requires 2 Sets						
	08-1505GB	Ganging Bracket Kit – Set of 2 with Thumb Screws					\$ 48
BRIDGE MODULAR CONFERENCE TOP KNIFE EDGE 	HPL						
	86-3045MCTBKH	27 1/2	30	—	16.1	2	P\$ 561 TXP\$ 606
	For Use with 30" Modular Tops						
	86-2445MCTBKH	22 3/4	24	—	10.8	1.4	P\$ 500 TXP\$ 540
	For Use with 24" Modular Tops						
	Description						
	<ul style="list-style-type: none"> • 45° Bridge Conference Top with Knife Edge • Connects Two Conference Tops • Pre-Drilled for Ganging Brackets • Not a Freestanding Unit • Ganging Brackets Required 						
	Options: Specify & Add						
	Ganging – Requires 2 Sets						
	08-1505GB	Ganging Bracket Kit – Set of 2 with Thumb Screws					\$ 48
BRIDGE MODULAR CONFERENCE TOP KNIFE EDGE 	HPL						
	86-3030MCTBKH	19 3/4	30	—	11.4	1.5	P\$ 525 TXP\$ 567
	For Use with 30" Modular Tops						
	86-2430MCTBKH	16 3/4	24	—	8.6	1.1	P\$ 476 TXP\$ 514
	For Use with 24" Modular Tops						
	Description						
	<ul style="list-style-type: none"> • 30° Bridge Conference Top with Knife Edge • Connects Two Conference Tops • Pre-Drilled for Ganging Brackets • Not a Freestanding Unit • Ganging Brackets Required 						
	Options: Specify & Add						
	Ganging – Requires 2 Sets						
	08-1505GB	Ganging Bracket Kit – Set of 2 with Thumb Screws					\$ 48

Tri-One™ Series – Laminate
 Multi-Use Tables – Knife Edge

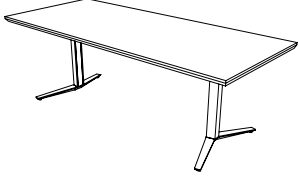
Item	Model No.	W	D	H	Ship Wt	Cubic Ft	List Price
RECTANGULAR MEETING TABLES KNIFE EDGE 	HPL						
	86-4296MTKH	96	42	—	122.2	9.4	P\$ 1306 TXP\$ 1410
	55" Kneespace						
	86-4284MTKH	84	42	—	106.9	8.2	P\$ 1226 TXP\$ 1324
	47" Kneespace						
	86-4272MTKH	72	42	—	91.7	7.1	P\$ 1090 TXP\$ 1177
	39" Kneespace						
	86-4260MTKH	60	42	—	76.4	5.7	P\$ 1000 TXP\$ 1080
	31½" Kneespace						
	86-3696MTKH	96	36	—	104.8	8.1	P\$ 1179 TXP\$ 1273
55" Kneespace							
86-3684MTKH	84	36	—	92	7.1	P\$ 1096 TXP\$ 1184	
47" Kneespace							
86-3672MTKH	72	36	—	78.6	6.1	P\$ 998 TXP\$ 1078	
39" Kneespace							
86-3660MTKH	60	36	—	65.5	5.1	P\$ 918 TXP\$ 991	
31½" Kneespace							

Description

- Seated Height Bases Required – Assembly Required

What You Need – Base (Not Available to be Sold Separately)
X-Base (2 Bases Required)

	Weight	Cubes	List Price
08-2630LXB	27	14.5	\$ 724

Y-Base

	Weight	Cubes	List Price
08-2828YLG96 For 96" Tables	47	6.5	\$ 1030
08-2828YLG84 For 84" Tables	43	5.4	\$ 1016
08-2828YLG72 For 72" Tables	39	4.3	\$ 994
08-2828YLG60 For 60" Tables	35	3.2	\$ 955

Power & Data

See Pages 92 – 97 for Power and Data Options

X-Base Detail

Y-Base Detail

Tri-One™ Series – Laminate
 Multi-Use Tables – Knife Edge

Item	Model No.	W	D	H	Ship Wt	Cubic Ft	List Price
SOFT RECTANGULAR MEETING TABLES KNIFE EDGE	HPL						
	86-4296SMTKH	96	42	—	122.2	9.4	P\$ 1262 TXP\$ 1363
	55" Kneespace						
	86-4284SMTKH	84	42	—	106.9	8.2	P\$ 1187 TXP\$ 1282
	47" Kneespace						
	86-4272SMTKH	72	42	—	91.7	7.1	P\$ 1055 TXP\$ 1139
	39" Kneespace						
	86-4260SMTKH	60	42	—	76.4	5.7	P\$ 969 TXP\$ 1047
	31½" Kneespace						
	86-3696SMTKH	96	36	—	104.8	8.1	P\$ 1136 TXP\$ 1227
55" Kneespace							
86-3684SMTKH	84	36	—	92	7.1	P\$ 1060 TXP\$ 1145	
47" Kneespace							
86-3672SMTKH	72	36	—	78.6	6.1	P\$ 965 TXP\$ 1042	
39" Kneespace							
86-3660SMTKH	60	36	—	65.5	5.1	P\$ 889 TXP\$ 960	
31½" Kneespace							

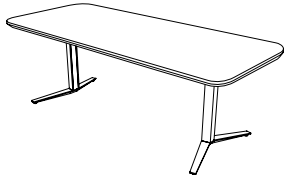
Description

- Seated Height Bases Required – Assembly Required

What You Need – Base (Not Available to be Sold Separately)
X-Base (2 Bases Required)

	Weight	Cubes	List Price
08-2630LXB	27	14.5	\$ 724

Y-Base

	Weight	Cubes	List Price
08-2828YLG96	47	6.5	\$ 1030
For 96" Tables			
08-2828YLG84	43	5.4	\$ 1016
For 84" Tables			
08-2828YLG72	39	4.3	\$ 994
For 72" Tables			
08-2828YLG60	35	3.2	\$ 955
For 60" Tables			

Power & Data

See Pages 92 – 97 for Power and Data Options

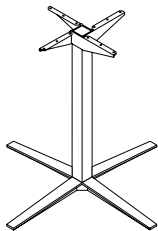

X-Base Detail

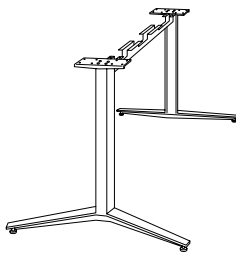

Y-Base Detail

Tri-One™ Series – Laminate
 Multi-Use Tables – Knife Edge

Item	Model No.	W	D	H	Ship Wt	Cubic Ft	List Price
SQUARE MEETING TABLES KNIFE EDGE	HPL						
	86-4242SQKH	42	42	—	70	3.3	P\$ 766 TXP\$ 827
	86-3636SQKH	36	36	—	37	2.5	P\$ 655 TXP\$ 707
	86-3030SQKH	30	30	—	30	2.2	P\$ 575 TXP\$ 621

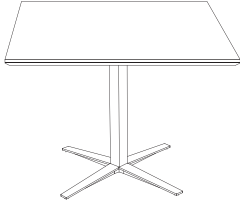

Description

- Bases Required – Assembly Required

What You Need – Base (Not Available to be Sold Separately)

Large X-Base – For Use with 42"

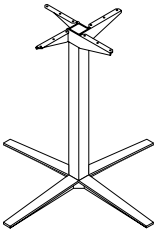
	Weight	Cubes	List Price
08-2642LXB 42" High Tables	33	20	\$ 785
08-2636LXB 36" High Tables	30	17.2	\$ 756
08-2630LXB 30" High Tables	27	14.5	\$ 724

Large X-Base Detail
Small X-Base – For Use with 36" and 30"

	Weight	Cubes	List Price
08-2042SXB 42" High Tables	27	15.9	\$ 732
08-2036SXB 36" High Tables	24	13.7	\$ 704
08-2030SXB 30" High Tables	21	11.6	\$ 675

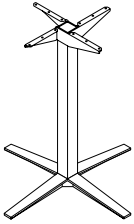
Small X-Base Detail

Tri-One™ Series – Laminate
 Multi-Use Tables – Knife Edge

Item	Model No.	W	D	H	Ship Wt	Cubic Ft	List Price
SOFT SQUARE MEETING TABLES KNIFE EDGE	HPL						
	86-4242SSQKH	42	42	–	70	3.3	P\$ 741 TXP\$ 800
	86-3636SSQKH	36	36	–	37	2.5	P\$ 635 TXP\$ 686
	86-3030SSQKH	30	30	–	30	2.2	P\$ 563 TXP\$ 608



Description

- Bases Required – Assembly Required

What You Need – Base (Not Available to be Sold Separately)

Large X-Base – For Use with 42"

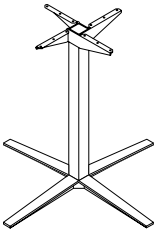
	Weight	Cubes	List Price
08-2642LXB 42" High Tables	33	20	\$ 785
08-2636LXB 36" High Tables	30	17.2	\$ 756
08-2630LXB 30" High Tables	27	14.5	\$ 724

Large X-Base Detail
Small X-Base – For Use with 36" and 30"

	Weight	Cubes	List Price
08-2042SXB 42" High Tables	27	15.9	\$ 732
08-2036SXB 36" High Tables	24	13.7	\$ 704
08-2030SXB 30" High Tables	21	11.6	\$ 675

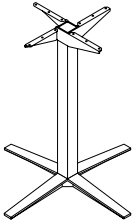
Small X-Base Detail

Tri-One™ Series – Laminate
 Multi-Use Tables – Knife Edge

Item	Model No.	W	D	H	Ship Wt	Cubic Ft	List Price
ROUND MEETING TABLES KNIFE EDGE	HPL						
	86-4848CTKH	48	48	—	95	4.3	P\$ 829 TXP\$ 895
	86-4242CTKH	42	42	—	70	3.3	P\$ 721 TXP\$ 779
	86-3636CTKH	36	36	—	37	2.5	P\$ 630 TXP\$ 680
	86-3030CTKH	30	30	—	30	2.2	P\$ 557 TXP\$ 602

Description

- Bases Required – Assembly Required

What You Need – Base *(Not Available to be Sold Separately)*
Large X-Base – For Use with 48" and 42"

	Weight	Cubes	List Price
08-2642LXB 42" High Tables	33	20	\$ 785
08-2636LXB 36" High Tables	30	17.2	\$ 756
08-2630LXB 30" High Tables	27	14.5	\$ 724

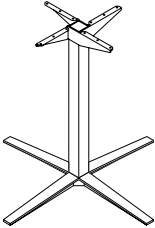
Large X-Base Detail
Small X-Base – For Use with 36" and 30"

	Weight	Cubes	List Price
08-2042SXB 42" High Tables	27	15.9	\$ 732
08-2036SXB 36" High Tables	24	13.7	\$ 704
08-2030SXB 30" High Tables	21	11.6	\$ 675

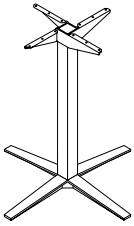
Small X-Base Detail

Tri-One™ Series – Laminate
 Multi-Use Tables – Knife Edge

Item	Model No.	W	D	H	Ship Wt	Cubic Ft	List Price
SOFT VIEW MEETING TABLES KNIFE EDGE	HPL						
	86-4296SVTKH	96	42 - 36	—	122.2	9.4	P\$ 1255 TXP\$ 1355
	86-4284SVTKH	84	42 - 36	—	106.9	8.2	P\$ 1134 TXP\$ 1225
	86-4272SVTKH	72	42 - 36	—	91.7	7.1	P\$ 1053 TXP\$ 1137

Description

- Seated Height Bases Required – Assembly Required

What You Need – Base (Not Available to be Sold Separately)
X-Base (2 Bases Required)

	Weight	Cubes	List Price
08-2630LXB	27	14.5	\$ 724

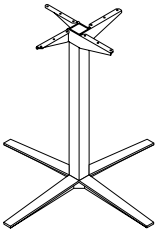

X-Base Detail

Y-Base

	Weight	Cubes	List Price
08-2828YLG96 For 96" Tables	47	6.5	\$ 1030
08-2828YLG84 For 84" Tables	43	5.4	\$ 1016
08-2828YLG72 For 72" Tables	39	4.3	\$ 994
08-2828YLG60 For 60" Tables	35	3.2	\$ 955

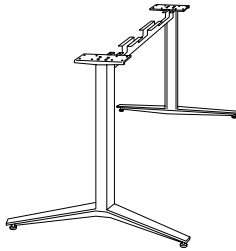

Y-Base Detail

Power & Data

See Pages 92 – 97 for Power and Data Options

Tri-One™ Series – Laminate
 Multi-Use Tables – Knife Edge

Item	Model No.	W	D	H	Ship Wt	Cubic Ft	List Price
ELLIPSE MEETING TABLES KNIFE EDGE	HPL 86-4284EMTKH	84	48	—	106.9	8.2	P\$ 1176 TXP\$ 1270
	86-3672EMTKH	72	30	—	78.6	6.1	P\$ 956 TXP\$ 1032

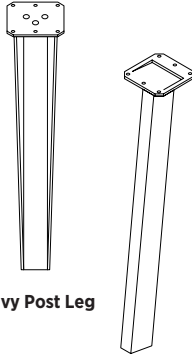
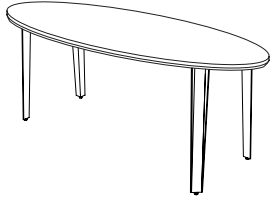
Envy Post Leg
Vantage Post Leg
Description

- Includes Stiffener Bar
- Base Required – Assembly Required

What You Need – Leg Assembly *(Not Available to be Sold Separately)*
Envy Post Leg

	Weight	Cubes	List Price
08-0227APL4	20	1.6	\$ 513
Set of 4			

Vantage Post Leg

	Weight	Cubes	List Price
08-0227SPL4	20	1.6	\$ 415
Set of 4			

Description

- Choose from Envy Post Leg or Vantage Post Leg
- Adjustable Glides
- Assembly Required

Power & Data

See Pages 92 – 97 for Power and Data Options

Tri-One™ Series – Laminate
Multi-Use Tables – Knife Edge

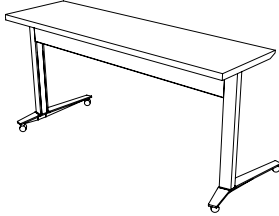
Item	Model No.	W	D	H	Ship Wt	Cubic Ft	List Price
 RECTANGULAR TRAINING TABLES – 18" DEEP KNIFE EDGE	HPL						
	86-1872TTKH	72	18	–	49.3	3.2	P\$ 679 TXP\$ 733
	65½ Kneespace						
	86-1860TTKH	60	18	–	42.7	2.7	P\$ 612 TXP\$ 661
	53¾ Kneespace						
	86-1848TTKH	48	18	–	36.2	2.2	P\$ 569 TXP\$ 615
	41½ Kneespace						

Description

- Flip Mechanism for Nesting is Optional; See Options Below
- Pre-Drilled for Ganging Brackets
- Base Required – Assembly Required

What You Need – Leg Assembly *(Not Available to be Sold Separately)*

Envy C-Leg Assembly – For 18" Tables

Casters – Must Specify Soft Wheel or Hard Wheel

	Weight	Cubes	List Price
08-1828CLC72	36	4.3	\$ 840
For 72" Tables			
08-1828CLC60	32	3.2	\$ 808
For 60" Tables			
08-1828CLC48	28	2.9	\$ 777
For 48" Tables			

Glides

08-1828CLG72	35	4.3	\$ 762
For 72" Tables			
08-1828CLG60	31	3.2	\$ 729
For 60" Tables			
08-1828CLG48	27	2.9	\$ 699
For 48" Tables			

Description

- Includes Trough/Modesty
- Legs Feature Removable Panels for Wire Management

Options: Specify & Add
Ganging

08-1505GB	Ganging Bracket Kit – Set of 2 with Thumb Screws	\$ 48
-----------	--	-------

Nesting

08-FLIP	Flip Mechanism for Nesting – Factory Installed	\$ 299
---------	--	--------

Power & Data

See Pages 92 – 97 for Power and Data Options

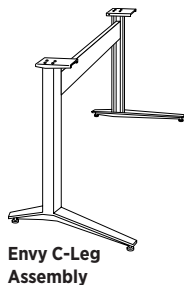

**Envy C-Leg
Assembly**

Tri-One™ Series – Laminate
Multi-Use Tables – Knife Edge

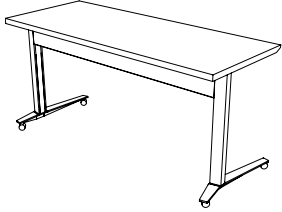
Item	Model No.	W	D	H	Ship Wt	Cubic Ft	List Price
 RECTANGULAR TRAINING TABLES – 24" DEEP KNIFE EDGE	HPL						
	86-2472TTKH	72	24	–	62.4	4.2	P\$ 753 TXP\$ 813
	65½ Kneespace						
	86-2460TTKH	60	24	–	53.7	3.5	P\$ 675 TXP\$ 729
	53¾ Kneespace						
	86-2448TTKH	48	24	–	44.9	2.8	P\$ 620 TXP\$ 670
	41½ Kneespace						

Description

- Flip Mechanism for Nesting is Optional; See Options Below
- Pre-Drilled for Ganging Brackets
- Base Required – Assembly Required

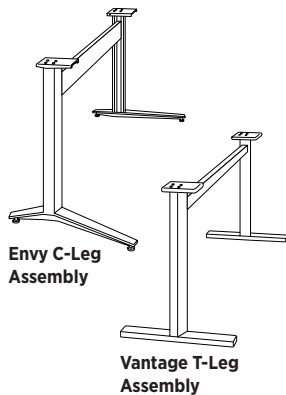
What You Need – Leg Assembly *(Not Available to be Sold Separately)*

Envy C-Leg Assembly – For 24" - 30" Tables
Casters – Must Specify Soft Wheel or Hard Wheel

	Weight	Cubes	List Price
08-2428CLC72 For 72" Tables	40	4.3	\$ 914
08-2428CLC60 For 60" Tables	36	3.2	\$ 879
08-2428CLC48 For 48" Tables	32	2.9	\$ 851

Glides

08-2428CLG72 For 72" Tables	39	4.3	\$ 833
08-2428CLG60 For 60" Tables	35	3.2	\$ 801
08-2428CLG48 For 48" Tables	31	2.9	\$ 772

Description

- Includes Trough/Modesty and Features Removable Panels for Wire Management

Options: Specify & Add
Ganging

08-1505GB	Ganging Bracket Kit – Set of 2 with Thumb Screws	\$ 48
-----------	--	-------

Nesting

08-FLIP	Flip Mechanism for Nesting – Factory Installed	\$ 299
---------	--	--------

Modesty Panel – For Use with Vantage T-Legs
Fixed – To Be Used with Standard Fixed Table Legs

	For	List Price
TFL: 86-0872MD	72	T\$ 312 TXT\$ 378
HPL: 86-0872MDH		P\$ 423 TXP\$ 457
TFL: 86-0860MD	60	T\$ 294 TXT\$ 356
HPL: 86-0860MDH		P\$ 398 TXP\$ 430
TFL: 86-0848MD	48	T\$ 285 TXT\$ 345
HPL: 86-0848MDH		P\$ 386 TXP\$ 417

Vantage T-Leg Assembly – For 24" - 30" Tables
Casters – Must Specify Soft Wheel or Hard Wheel

	Weight	Cubes	List Price
08-2428TLC72 For 72" Tables	36	4.3	\$ 437
08-2428TLC60 For 60" Tables	32	3.2	\$ 418
08-2428TLC48 For 48" Tables	28	2.9	\$ 402

Glides

08-2428TLG72 For 72" Tables	35	4.3	\$ 421
08-2428TLG60 For 60" Tables	31	3.2	\$ 402
08-2428TLG48 For 48" Tables	27	2.9	\$ 386

Description

- Includes Stretcher Rail
- Optional Modesty Sold Below

Hinged – To Be Used with Flip Mechanism for Nesting

	For	List Price
TFL: 86-0865HMD	72	T\$ 312 TXT\$ 378
HPL: 86-0865HMDH		P\$ 423 TXP\$ 457
TFL: 86-0853HMD	60	T\$ 295 TXT\$ 357
HPL: 86-0853HMDH		P\$ 400 TXP\$ 432
TFL: 86-0841HMD	48	T\$ 286 TXT\$ 346
HPL: 86-0841HMDH		P\$ 388 TXP\$ 419

Power & Data

See Pages 92 – 97 for Power and Data Options

Tri-One™ Series – Laminate
Multi-Use Tables – Knife Edge

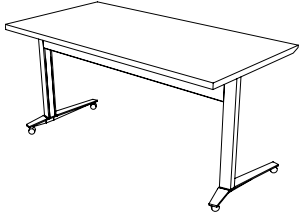
Item	Model No.	W	D	H	Ship Wt	Cubic Ft	List Price
 RECTANGULAR TRAINING TABLES – 30" DEEP KNIFE EDGE	HPL						
	86-3072TTKH	72	30	–	75.5	5.2	P\$ 824 TXP\$ 890
	65½ Kneespace						
	86-3060TTKH	60	30	–	53.7	4.3	P\$ 735 TXP\$ 794
	53½ Kneespace						
	86-3048TTKH	48	30	–	53.7	3.5	P\$ 669 TXP\$ 723
	41½ Kneespace						

Description

- Flip Mechanism for Nesting is Optional; See Options Below
- Pre-Drilled for Ganging Brackets
- Base Required – Assembly Required

What You Need – Leg Assembly *(Not Available to be Sold Separately)*
Envy C-Leg Assembly – For 24" - 30" Tables
Casters – Must Specify Soft Wheel or Hard Wheel

	Weight	Cubes	List Price
08-2428CLC72 For 72" Tables	40	4.3	\$ 914
08-2428CLC60 For 60" Tables	36	3.2	\$ 879
08-2428CLC48 For 48" Tables	32	2.9	\$ 851

Glides

08-2428CLG72 For 72" Tables	39	4.3	\$ 833
08-2428CLG60 For 60" Tables	35	3.2	\$ 801
08-2428CLG48 For 48" Tables	31	2.9	\$ 772

Description

- Includes Trough/Modesty and Features Removable Panels for Wire Management

Options: Specify & Add
Ganging

08-1505GB	Ganging Bracket Kit – Set of 2 with Thumb Screws	\$ 48
-----------	--	-------

Nesting

08-FLIP	Flip Mechanism for Nesting – Factory Installed	\$ 299
---------	--	--------

Modesty Panel – For Use with Vantage T-Legs
Fixed – To Be Used with Standard Fixed Table Legs

	For	List Price
TFL: 86-0872MD	72	T\$ 312 TXT\$ 378
HPL: 86-0872MDH		P\$ 423 TXP\$ 457
TFL: 86-0860MD	60	T\$ 294 TXT\$ 356
HPL: 86-0860MDH		P\$ 398 TXP\$ 430
TFL: 86-0848MD	48	T\$ 285 TXT\$ 345
HPL: 86-0848MDH		P\$ 386 TXP\$ 417

Power & Data

See Pages 92 – 97 for Power and Data Options

Vantage T-Leg Assembly – For 24" - 30" Tables
Casters – Must Specify Soft Wheel or Hard Wheel

	Weight	Cubes	List Price
08-2428TLC72 For 72" Tables	36	4.3	\$ 437
08-2428TLC60 For 60" Tables	32	3.2	\$ 418
08-2428TLC48 For 48" Tables	28	2.9	\$ 402

Glides

08-2428TLG72 For 72" Tables	35	4.3	\$ 421
08-2428TLG60 For 60" Tables	31	3.2	\$ 402
08-2428TLG48 For 48" Tables	27	2.9	\$ 386

Description

- Includes Stretcher Rail
- Optional Modesty Sold Below

Tri-One™ Laminate

Multi-Use Table Collection

Urethane Edge

How to Order

	QTY	MODEL NO.	DESCRIPTION	
TOP	10	86-2472TTU	Laminate Color	PTM
		08-FLIP	Flip Mechanism	
BASE	10	08-1828CLC72	Optional Caster	Soft Caster
DATA	10	01-PDUUNDERW		
	2	01-PPOWER		
	5	01-2JUMP		



Specifications

TOPS

Tops are 1-3/16" high-pressure laminate (HPL) fused to particle-board core. Select from solid color and patterned laminates. The Comfort (U1) profile and the Ultra-Flex (U2) profile are urethane edges in coordinating colors. Training tops feature shaped profiles on the user side only. Tops are pre-drilled for the specified base assembly and for ganging where applicable.

LEG ASSEMBLY

All leg styles are powder-coated aluminum and include a 5mm steel mounting plate. Envy style legs are aluminum extrusion while Vantage style legs are steel welded. Envy C-Legs and Envy Y-Legs include troughs which act as modesty panels and route cables cleanly to the legs where a removable panel provides access. Vantage T-Legs are equipped with a stretcher rail for secure support. All legs include adjustable glides or casters.

FLIP MECHANISM

Indiana Furniture's training tables offer an exclusive flip mechanism design which can be accessed from any position. Optional flip mechanisms are factory installed and must be specified at the time of order.

GANGING

All training tables are pre-drilled with threaded inserts for ganging applications. Ganging brackets include quick release thumb screws for ease of use. No tools required.

POWER PORTS

Power ports are available for under-surface mount or routed into work surfaces. Units comply with FCC Part 15A and UL. Both standard plugs and daisy-chain connections are offered. Daisy chain applications are non-sequential and connect up to 8 modules.



Laminate Options – Tops

STANDARD HPL (P) WITH URETHANE EDGES – MUST SPECIFY

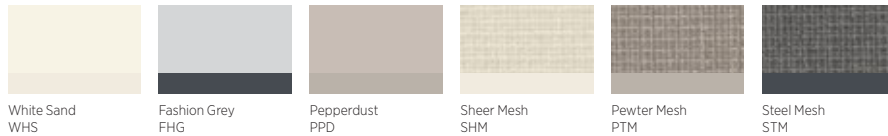

Laminate Options – Modesty Panels

TFL (T) – MUST SPECIFY



HPL (P) – MUST SPECIFY



TEXTURED TFL (TXT) AND HPL (TXP) – MUST SPECIFY



Note: See Tri-One Laminate – Square Edge for more laminate options for modesty panels.

Edge Options

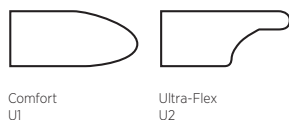

WIRE MANAGEMENT GROMMET

Optional black grommets are available in Training Tables. Please specify any combination of Left, Right, and Center and add \$47 list for each grommet.

Specify & Add: GL – Grommet Left
GR – Grommet Right
GC – Grommet Center

Grommets may be ordered in non-standard locations. Please call Customer Service to assist with how to order and additional lead time requirements.

24" Training Tables



GL/GR – 10" from end, 16.5" from user side
GC – Grommet Center – 16.5" from user side

30" Training Tables

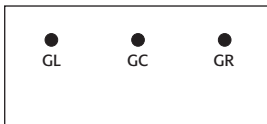

GL/GR – 10" from end, 20" from user side
GC – Grommet Center – 20" from user side

POWER ACCESSORIES

Indiana Furniture offers Power Accessories for training tables that can be mounted below the worksurface or in the worksurface top. Power Accessories that include a bezel frame will be routed for field placement at no additional charge. See pages 92-97 to specify and order Power Accessories.

Power Accessories will be routed on center, left to right:

- 24" Training Tables – 16.5" from user side
- 30" Training Tables – 20" from user side

Tri-One™ Series – Laminate

Multi-Use Tables – Urethane Edge

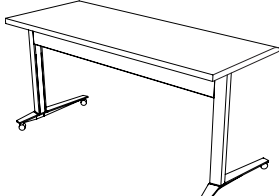
Item	Model No.	W	D	H	Ship Wt	Cubic Ft	List Price
RECTANGULAR TRAINING TABLES – 24" DEEP URETHANE EDGE 	HPL						
	86-2472TTU 65½ Kneespace	72	24	–	62.4	4.2	P\$ 1277
	86-2460TTU 53½ Kneespace	60	24	–	53.7	3.5	P\$ 1143
	86-2448TTU 41½ Kneespace	48	24	–	44.9	2.8	P\$ 1050

Description

- Flip Mechanism for Nesting is Optional; See Options Below
- Pre-Drilled for Ganging Brackets
- Base Required – Assembly Required

What You Need – Leg Assembly (Not Available to be Sold Separately)

Envy C-Leg Assembly – For 24" - 30" Tables

Casters – Must Specify Soft Wheel or Hard Wheel

	Weight	Cubes	List Price
08-2428CLC72 For 72" Tables	40	4.3	\$ 914
08-2428CLC60 For 60" Tables	36	3.2	\$ 879
08-2428CLC48 For 48" Tables	32	2.9	\$ 851

Glides

08-2428CLG72 For 72" Tables	39	4.3	\$ 833
08-2428CLG60 For 60" Tables	35	3.2	\$ 801
08-2428CLG48 For 48" Tables	31	2.9	\$ 772

Description

- Includes Trough/Modesty and Features Removable Panels for Wire Management

Options: Specify & Add
Ganging

08-1505GB	Ganging Bracket Kit – Set of 2 with Thumb Screws	\$ 48
-----------	--	-------

Nesting

08-FLIP	Flip Mechanism for Nesting – Factory Installed	\$ 299
---------	--	--------

Modesty Panel – For Use with Vantage T-Legs

Fixed – To Be Used with Standard Fixed Table Legs

	For	List Price
TFL: 86-0872MD	72"	T\$ 312 TXT\$ 378
HPL: 86-0872MDH		P\$ 423 TXP\$ 457
TFL: 86-0860MD	60"	T\$ 294 TXT\$ 356
HPL: 86-0860MDH		P\$ 398 TXP\$ 430
TFL: 86-0848MD	48"	T\$ 285 TXT\$ 345
HPL: 86-0848MDH		P\$ 386 TXP\$ 417

Vantage T-Leg Assembly – For 24" - 30" Tables

Casters – Must Specify Soft Wheel or Hard Wheel

	Weight	Cubes	List Price
08-2428TLC72 For 72" Tables	36	4.3	\$ 437
08-2428TLC60 For 60" Tables	32	3.2	\$ 418
08-2428TLC48 For 48" Tables	28	2.9	\$ 402

Glides

08-2428TLG72 For 72" Tables	35	4.3	\$ 421
08-2428TLG60 For 60" Tables	31	3.2	\$ 402
08-2428TLG48 For 48" Tables	27	2.9	\$ 386

Description

- Includes Stretcher Rail
- Optional Modesty Sold Below

Hinged – To Be Used with Flip Mechanism for Nesting

	For	List Price
TFL: 86-0865HMD	72"	T\$ 312 TXT\$ 378
HPL: 86-0865HMDH		P\$ 423 TXP\$ 457
TFL: 86-0853HMD	60"	T\$ 295 TXT\$ 357
HPL: 86-0853HMDH		P\$ 400 TXP\$ 432
TFL: 86-0841HMD	48"	T\$ 286 TXT\$ 346
HPL: 86-0841HMDH		P\$ 388 TXP\$ 419

Power & Data

See Pages 92 – 97 for Power and Data Options

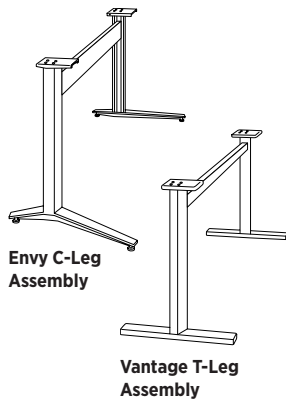

Tri-One™ Series – Laminate

Multi-Use Tables – Urethane Edge

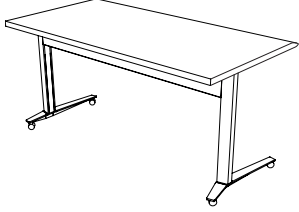
Item	Model No.	W	D	H	Ship Wt	Cubic Ft	List Price
RECTANGULAR TRAINING TABLES – 30" DEEP URETHANE EDGE 	HPL						
	86-3072TTU 65½ Kneespace	72	30	–	75.5	5.2	P\$ 1396
	86-3060TTU 53¾ Kneespace	60	30	–	64.6	4.3	P\$ 1245
	86-3048TTU 41½ Kneespace	48	30	–	53.7	3.5	P\$ 1134

Description

- Flip Mechanism for Nesting is Optional; See Options Below
- Pre-Drilled for Ganging Brackets
- Base Required – Assembly Required

What You Need – Leg Assembly *(Not Available to be Sold Separately)*

Envy C-Leg Assembly – For 24" - 30" Tables

Casters – Must Specify Soft Wheel or Hard Wheel

	Weight	Cubes	List Price
08-2428CLC72 For 72" Tables	40	4.3	\$ 914
08-2428CLC60 For 60" Tables	36	3.2	\$ 879
08-2428CLC48 For 48" Tables	32	2.9	\$ 851

Glides

08-2428CLG72 For 72" Tables	39	4.3	\$ 833
08-2428CLG60 For 60" Tables	35	3.2	\$ 801
08-2428CLG48 For 48" Tables	31	2.9	\$ 772

Description

- Includes Trough/Modesty and Features Removable Panels for Wire Management

Options: Specify & Add
Ganging

08-1505GB	Ganging Bracket Kit – Set of 2 with Thumb Screws	\$ 48
-----------	--	-------

Nesting

08-FLIP	Flip Mechanism for Nesting – Factory Installed	\$ 299
---------	--	--------

Modesty Panel – For Use with Vantage T-Legs

Fixed – To Be Used with Standard Fixed Table Legs

	For	List Price
TFL: 86-0872MD	72"	T\$ 312 TXT\$ 378
HPL: 86-0872MDH		P\$ 423 TXP\$ 457
TFL: 86-0860MD	60"	T\$ 294 TXT\$ 356
HPL: 86-0860MDH		P\$ 398 TXP\$ 430
TFL: 86-0848MD	48"	T\$ 285 TXT\$ 345
HPL: 86-0848MDH		P\$ 386 TXP\$ 417

Power & Data

See Pages 92 – 97 for Power and Data Options

Vantage T-Leg Assembly – For 24" - 30" Tables

Casters – Must Specify Soft Wheel or Hard Wheel

	Weight	Cubes	List Price
08-2428TLC72 For 72" Tables	36	4.3	\$ 437
08-2428TLC60 For 60" Tables	32	3.2	\$ 418
08-2428TLC48 For 48" Tables	28	2.9	\$ 402

Glides

08-2428TLG72 For 72" Tables	35	4.3	\$ 421
08-2428TLG60 For 60" Tables	31	3.2	\$ 402
08-2428TLG48 For 48" Tables	27	2.9	\$ 386

Description

- Includes Stretcher Rail
- Optional Modesty Sold Below

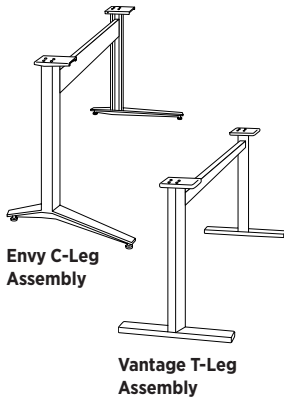

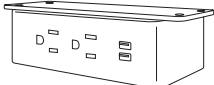
Item	Model No.	W	D	H	Ship Wt	Cubic Ft	List Price
UNDERMOUNT DUO NEMA PLUG 	01-DUOUNDERW White				—	—	\$ 345
	01-DUOUNDERB Black				—	—	\$ 345
	01-DUOUNDER S Silver				—	—	\$ 345

Description

- Sits Under the Worksurface
- 2 Power / 2 USB Power
- Independent USB Circuit Controllers Deliver up to 2.1 Amps to Each Post
- All Mounting Hardware Included
- FCC Part 15A and UL Approved for Horizontal and Vertical Applications
- 10' Cord

Applications

- Small Conference/Meeting Tables

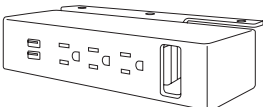
UNDERMOUNT TRIO NEMA PLUG 	01-TRIOUNDERW White				—	—	\$ 413
	01-TRIOUNDERB Black				—	—	\$ 413
	01-TRIOUNDER S Silver				—	—	\$ 413

Description

- Sits Under the Worksurface
- 3 Power / 2 USB Power / 1 Open Data
- Independent USB Circuit Controllers Deliver up to 2.1 Amps to Each Post
- HDMI, VGA, or RJ45 Accessories Sold Separately
- All Mounting Hardware Included
- FCC Part 15A and UL Approved for Horizontal and Vertical Applications
- 10' Cord

Applications

- Small Conference/Meeting Tables

Item	Model No.	W	D	H	Ship Wt	Cubic Ft	List Price
UNDERMOUNT DUO DAISY CHAIN PLUG 	01-PDUUNDERW White				—	—	\$ 340
	01-PDUUNDERB Black				—	—	\$ 340
	01-PDUUNDERS Silver				—	—	\$ 340

Description

- Sits Under the Worksurface
- 2 Power / 2 USB Power
- Independent USB Circuit Controllers Deliver up to 2.1 Amps to Each Post
- All Mounting Hardware Included
- FCC Part 15A and UL Approved for Horizontal Applications
- Non Sequential System Allows Up To 8 Modules To Be Connected With Jumper Cord
- Requires Power Box, See Page 97
- 12" Cord

Applications

- Standard Conference Tables
- Small Conference/Meeting Tables

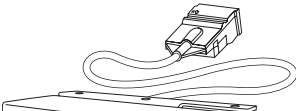
UNDERMOUNT TRIO DAISY CHAIN PLUG 	01-PTRIOUNDERW White				—	—	\$ 408
	01-PTRIOUNDERB Black				—	—	\$ 408
	01-PTRIOUNDERS Silver				—	—	\$ 408

Description

- Sits Under the Worksurface
- 3 Power / 2 USB Power / 1 Open Data
- HDMI, VGA, or RJ45 Accessories Sold Separately
- All Mounting Hardware Included
- FCC Part 15A and UL Approved for Horizontal Applications
- Non Sequential System Allows up to 8 Modules to be Connected with Jumper Cord
- Requires Power Box, See Page 97
- 12" Cord

Applications

- Standard Conference Tables
- Small Conference/Meeting Tables

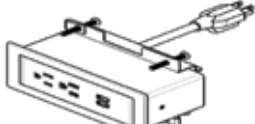
Item	Model No.	W	D	H			Ship Wt	Cubic Ft	List Price
DUO BEZEL NEMA PLUG 	01-DUOBEZELW White	6½	2¾	3¼	—	—			\$ 415
	01-DUOBEZELB Black	6½	2¾	3¼	—	—			\$ 415
	01-DUOBEZELS Silver	6½	2¾	3¼	—	—			\$ 415

Description

- Sits On Top of the Worksurface
- 2 Power / 2 USB Power
- Independent USB Circuit Controllers Deliver up to 2.1 Amps to Each Post
- All Mounting Hardware Included
- FCC Part 15A and UL Approved for Horizontal and Vertical Applications
- 10' Cord

Applications

- Standard Conference Tables
- Small Conference/Meeting Tables

TRIO BEZEL NEMA PLUG 	01-TRIOBEZELW White	9	2¾	3	—	—			\$ 445
	01-TRIOBEZELB Black	9	2¾	3	—	—			\$ 445
	01-TRIOBEZELS Silver	9	2¾	3	—	—			\$ 445

Description

- Sits On Top of the Worksurface
- 3 Power / 2 USB Power / 1 Open Data
- Independent USB Circuit Controllers Deliver up to 2.1 Amps to Each Post
- HDMI, VGA, or RJ45 Accessories Sold Separately
- All Mounting Hardware Included
- FCC Part 15A and UL Approved for Horizontal and Vertical Applications
- 10' Cord

Applications

- Standard Conference Tables
- Small Conference/Meeting Tables

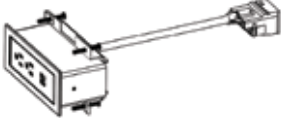
Item	Model No.	W	D	H	Ship Wt	Cubic Ft	List Price
DUO BEZEL DAISY CHAIN PLUG 	01-PDUOBEZELW White	6½	2¼	3	—	—	\$ 410
	01-PDUOBEZELB Black	6½	2¼	3	—	—	\$ 410
	01-PDUOBEZELS Silver	6½	2¼	3	—	—	\$ 410

Description

- Sits On Top of the Worksurface
- 2 Power / 2 USB Power
- Independent USB Circuit Controllers Deliver up to 2.1 Amps to Each Post
- All Mounting Hardware Included
- FCC Part 15A and UL Approved for Horizontal and Vertical Applications
- Non Sequential System Allows Up To 8 Modules To Be Connected With Jumper Cord
- Requires Power Box, See Page 97
- 12" Cord

Applications

- Standard Conference Tables
- Small Conference/Meeting Tables

TRIO BEZEL DAISY CHAIN PLUG 	01-PTRIOBEZELW White	9	2¼	3	—	—	\$ 439
	01-PTRIOBEZELB Black	9	2¼	3	—	—	\$ 439
	01-PTRIOBEZELS Silver	9	2¼	3	—	—	\$ 439

Description

- Sits On Top of the Worksurface
- 3 Power / 2 USB Power / 1 Open Data
- HDMI, VGA, or RJ45 Accessories Sold Separately
- All Mounting Hardware Included
- FCC Part 15A and UL Approved for Horizontal and Vertical Applications
- Non Sequential System Allows up to 8 Modules to be Connected with Jumper Cord
- Requires Power Box, See Page 97
- 12" Cord

Applications

- Standard Conference Tables
- Small Conference/Meeting Tables

Item	Model No.	W	D	H	Ship Wt	Cubic Ft	List Price
TRIO VGA DATA PORT ACCESSORY	01-LCOMVGA	-	-	-	-	-	\$ 75

Description

- VGA Port for Trio Units

TRIO HDMI DATA PORT ACCESSORY	01-LCOMHDMI	-	-	-	-	-	\$ 101
----------------------------------	-------------	---	---	---	---	---	--------



Open
Market
Only

Description

- HDMI Port for Trio Units

TRIO RJ45 DATA PORT ACCESSORY	01-LCOMRJ45	-	-	-	-	-	\$ 48
----------------------------------	-------------	---	---	---	---	---	-------

Description

- RJ45 Port for Trio Units

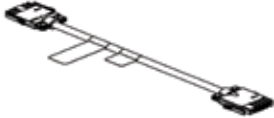
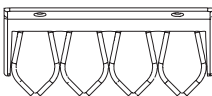
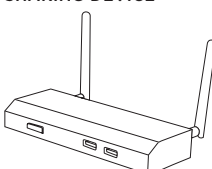
Item	Model No.	W	D	H	Ship Wt	Cubic Ft	List Price
DAISY CHAIN POWER BOX 	01-PPOWER 76" Perimeter, 36" Power Cord				—	—	\$ 475
	01-PPOWER2 24" Perimeter, 144" Power Cord				—	—	\$ 503
Description <ul style="list-style-type: none"> • Powers up to 8 Duo and Trio Daisy Chain Units • One Nema Plug and One Daisy Chain Plug • 12 Amp System Rating • 15 Amp Over-Current Protection 							
DAISY CHAIN JUMPER CORD 	01-6Jump 72" Long				—	—	\$ 185
	01-5Jump 60" Long				—	—	\$ 174
	01-4Jump 48" Long				—	—	\$ 148
	01-2Jump 24" long				—	—	\$ 135
Description <ul style="list-style-type: none"> • Connects Duo and Trio Daisy Chain Units • Non Sequential System Allows up to 8 Modules to be Connected 							
CABLE GRIP 	01-WMGRCB	5%	2%		—	—	\$ 12
Description <ul style="list-style-type: none"> • Under Surface Wire Management • Black 							
WIRELESS PRESENTATION SHARING DEVICE 	01-WEPRESENT				—	—	\$ 2268
Description <ul style="list-style-type: none"> • Wireless Presentation Device • Works well with Media Credenza and Monitor Stand • Compatible with Any Wireless Device • Allows 64 users to connect and participate in screen sharing - 4 at a time • Users must download WiFi-Doc for each device for free 							

Indiana[®]
FURNITURE

1224 Mill Street
PO Box 270
Jasper, Indiana 47547-0270
Tel 812.482.5727
Tol 800.422.5727
Fax 812.482.9035
sales@indianafurniture.com

www.indianafurniture.com



Federal Classification: Small Business